

CB Ceramic Band Heater

- 3-12" Barrel Dia.
- 1-1/2 - 6" Widths
- 500 - 5,000 Watts
- 120 to 600 Volts
- 18 - 40 W/In²
- Ceramic Fiber Insulated
- Up to 1600°F Band Operating Temp.
- Corrosion - Resistant Alloy Shell

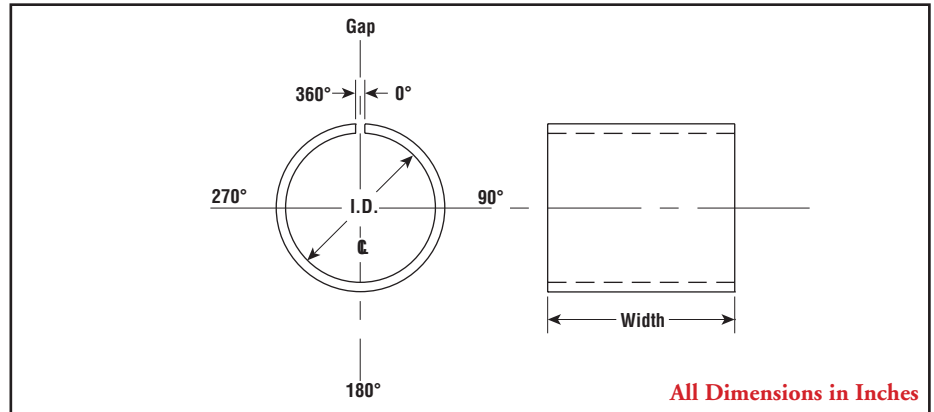

Dimensions



Applications

- Blow Molding
- Die Heads
- Extruders
- Heating Pipes
- Injection Molding

Features

Type CB ceramic band heaters are best suited for applications up to 1600°F Band operating temperatures and provide even heating on injection and extrusion molding barrels. The ceramic segments and high temperature resistance wires are capable of highly efficient heat transfer. Ceramic fiber insulation, 1/4" thickness, provides an additional 25% energy savings over non-insulated types. Ceramic bands also contribute a radiant heating effect to the object being heated. They can be constructed in greater widths, allowing fewer heaters per zone, wider heating patterns, and simplified wiring.

Energy Efficient, 25% Savings

Radiant Heating Principle

Uniform Heating Pattern

Available in **Special** Configurations

Thermal Insulation

1600°F Band Operating Temperatures

Flexible

Corrosion-Resistant Alloy Shell

High Temperature Resistance Wires

Construction

The use of ceramic inserts to support high temperature resistance wire allows the Chromalox Type CB ceramic heater band to operate at high temperatures reaching 1500°F. Corrosion resistant metal is slit along the edges to allow easy fitting of the shroud to the object being heated.

Insulation — 1/4" of ceramic fiber is placed between the inserts and the shroud to provide a 25% energy savings over non-insulated heater bands. Additional insulation and metal liners can be supplied as an option.

Clamping Method — Mounting flanges are standard on Chromalox ceramic bands. Other clamping methods are available.

Terminations — Due to the high temperature capabilities of ceramic insulated heat bands, the use of lead wires is not recommended. When leads must be supplied, Chromalox will exit the heater with ceramic wire insulating beads, and make a junction with the nickel alloy lead wire at a point outside the shroud. Terminals are generally best located 180° from the gap. Alternate locations are possible, consult factory.

Sensor Holes — Sensor holes should be positioned in the gap, and a shroud be supplied as a shell overlap construction. For holes through the elements, consult factory.

Chromalox CB Ceramic Band Heaters

Style Variations and Clamping Options

Variations

One-Piece

Standard completely flexible construction consists of flange lockup, 1/4" thick ceramic insulation, 1/4-20 screw terminals, located 180° from gap, on width center line.

Max. I.D. 21"
Min. Width 1-1/2"

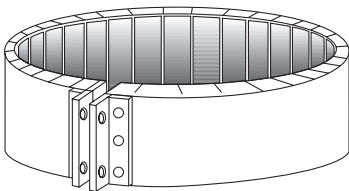

Two-Piece

Easy to apply when an obstruction prohibits the application of 1-piece heater. Heaters can be supplied with any termination or clamping variation. 2-piece heaters are rated at half of the voltage and each half is rated half of the total wattage. Larger diameters made in multiple segments.

Min. I.D. 4"
Width 1-1/2"
Max. I.D. 44"

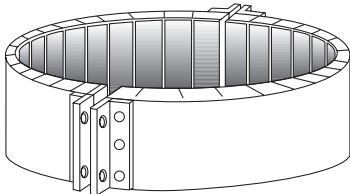

Partial Coverage

Allows for the heating of the accessible portion of machine when full coverage is not possible. Heaters supplied with standard clamping and termination.

Min. length 6"
Max. length 21"

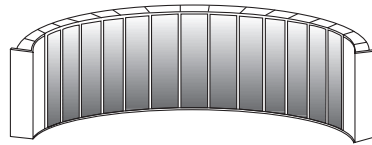

Liner

Stainless steel liners inhibit contamination of the ceramic tiles.

Min. I.D. 3"
Width 1-1/2"
Max. I.D. 21"

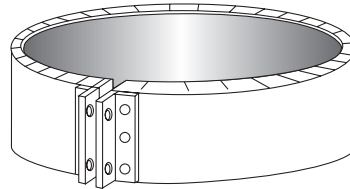

Special Insulation

1/2" ceramic fiber insulation can be inserted. The thickness of the heater will expand to 3/4". When 3/4" ceramic fiber and an inner liner is inserted the heater will be 7/8" thick.

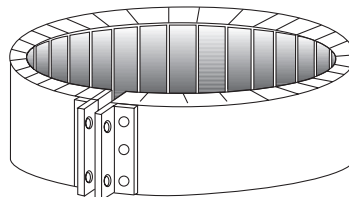

Clamping

Bent-Up Flange - F

Flange clamping is standard construction on ceramic heaters

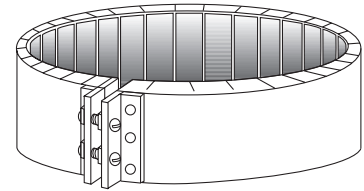

Built-In Bracket - BB

Mounting bracket with barrel nut lockup, and 1/4-20 screws. Supplied in any construction or termination variation.

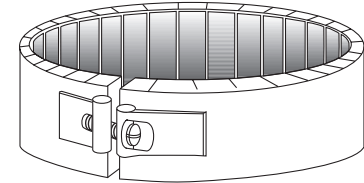

Latch and Trunion - LT

Quick Release Spring loaded latch & trunion. Recommended I.D. 12" or greater.

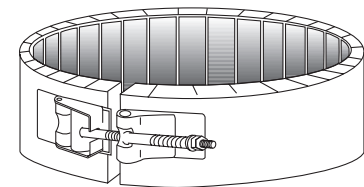

Chromalox CB Ceramic Band Heaters

Style Variations and Clamping Options

Terminations

Tandem T-2

Tandem terminals located 180° from gap, on center line with length of heater. Available with 1/4-20 post terminals. Standard on widths under 3".

Min. I.D. 3"

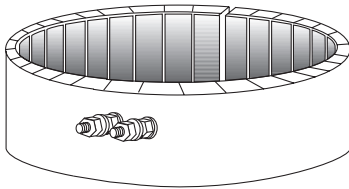

Euro Plug - EP

Quick disconnect cup assembly is a safe way to provide power to heater.

Min. Width 1-1/2"

Max. Amps 15 at 240V, Max. Volts 240

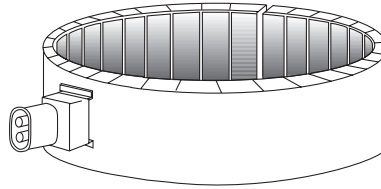

Options

Terminal Box Protection - TB

Designed in standard height of 1-3/4" high, with 5/8" conduit knockout for standard metal conduit connections. Protects terminals from damage, spill leakage, grounding or short circuiting. Available for single or 3-phase construction. For conduit connections, consult factory.

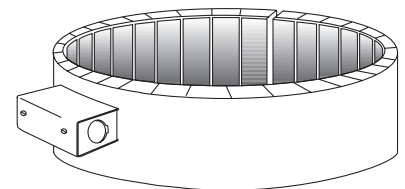

Parallel T-3

Parallel terminals located 180° from gap with width of heater. Available with 1/4-20 post terminals. Standard on all heaters greater than 3" width.

Min. I.D. 3"

Min. Width 3"

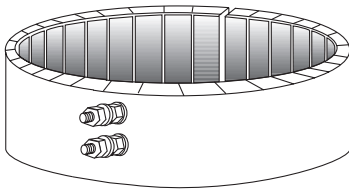

Lead Types

Stainless Steel Metal Braid - C

Provides abrasion resistant protection of fiberglass leads. Leads exit one point of heater surface through a strain relief. 10" braid over 12" leads, standard.

Min. I.D. 3"

Min. Width 1-1/2"

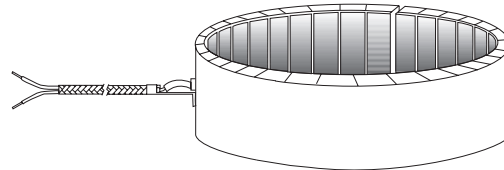

Standoff Terminals - SO

Provides relief from direct heat. Available on any construction or clamping variation. Single or 3-phase power, single or dual voltage.

Min. I.D. 3"

Min. Width 3"

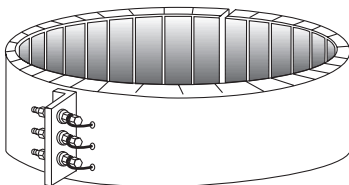

Metal Flexible Conduit - M

Stainless steel or galvanized. Flexible metal conduit to protect leads from abrasion. Available on any construction or clamping variation. 10" metal conduit over 12" fiberglass leads, standard.

Min. I.D. 3"

Min. Width 1-1/2"

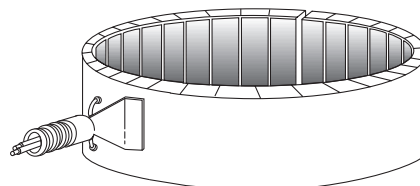

Chromalox CB Ceramic Band Heaters

Clamping Options and Ordering Information

Options (cont'd.)

Shroud Overlap

Shroud overlap designed to accommodate a thermocouple hole in gap. This is the preferred way of adding a thermocouple hole. Heaters can be supplied with any termination or clamping variation.

Min. I.D. 5"
Width 1-1/2"
Max. I.D. 21"

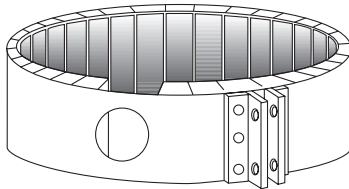

Ceramic Caps - CC

Protects against electric shock, when used with insulated wire. Can be rotated at any angle - Screw size 1/4-20 standard.

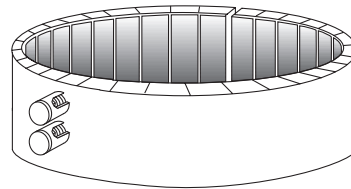

How to Order Ceramic Bands

1. Order by Catalog Code and PCN
2. Specify quantity
3. Specify Inside diameter (ID)
4. Specify Width (1/2" increments)
5. Wattage - 2-piece bands each half is rated one-half the wattage.
6. Voltage on 2-piece bands, we recommend each piece is rated at half the operating voltage.
7. Terminal type - post terminals are standard, specify terminal location.
8. Standard 1/4" insulated or optional 1/2" insulation.
9. Indicate size and location of thermocouple holes, cutouts, partial coverage, gaps or other special features - Fax Drawing.

Specifications

Sheath Material	Corrosion resistant alloy shroud
Maximum Temperature	1600°F
Insulation Material	Thickness of heater with 1/4" insulation = 5/8 Thickness of heater with 1/2" insulation = 3/4"
Minimum I.D.	3"
Minimum Width/Tolerance	1-1/2" wide Width in 1/2" increments Width tolerance: ± 1/8"
Standard Gap When Tightened	3/8" ± 1/8"
Resistance Tolerance	NEMA standard + 10% -5%
Wattage Tolerance	NEMA standard +5% -10%
Watt Density	Depends on power, operating temperature and heater size. See ordering information.
Maximum Volts	600 volts
Maximum Amps	25 amps

Chromalox CB Ceramic Band Heaters

Specifications and Ordering Information

Watts	W/In ²	Dimensions (In.)		Terminal Type	120V			240V		
		I.D.	Width		Model	Stock	PCN	Model	Stock	PCN
500	40	3	1-1/2	T2	CB3A1J1P1	NS	160012	CB3A1J1P2	NS	160020
700	26	3	3	T3	CB3A3A1P1	NS	160055	CB3A3A1P2	NS	160063
1500	40	3	4	T3	CB3A4A1P1	NS	160071	CB3A4A1P2	NS	160080
1350	28	3	6	T3	CB3A6A1P1	NS	160098	CB3A6A1P2	NS	160100
1800	35	3	6	T3	CB3A6A1P3	NS	160119	CB3A6A1P4	NS	160127
600	38	3-1/2	1-1/2	T2	—	—	—	CB3J1J1P1	NS	160135
650	30	3-1/2	2	T2	CB3J2A1P1	NS	160143	CB3J2A1P2	NS	160151
800	37	3-1/2	3	T3	CB3J3A1P1	NS	160160	CB3J3A1P2	NS	160178
1200	30	3-1/2	4	T3	—	—	—	CB3J4A1P1	NS	160186
1000	23	3-1/2	4-1/2	T3	CB3J4J1P1	NS	160194	CB3J4J1P2	NS	160207
800	22	4	2	T2	CB4A2A1P1	S	160223	CB4A2A1P2	S	160231
1200	35	4	3	T3	CB4A3A1P1	S	160240	CB4A3A1P2	S	160258
1200	26	4	4	T3	—	—	—	CB4A4A1P1	NS	160266
2500	38	4	6	T3	—	—	—	CB4A6A1P1	S	160274
700	35	4-1/2	1-1/2	T2	CB4A6A1P3	S	160282	—	—	—
1100	40	4-1/2	2	T2	—	—	—	CB4J2A1P1	S	160290
1000	19	4-1/2	4	T3	CB4J4A1P1	S	160303	CB4J4A1P2	S	160311
2000	26	4-1/2	6	T3	—	—	—	CB4J6A1P1	S	160346
800	35	5	1-1/2	T2	—	—	—	CB5A1J1P1	S	160354
850	19	5	3	T3	CB5A3A1P1	S	160370	—	—	—
1250	28	5	3	T3	CB5A3A1P2	S	160389	CB5A3A1P3	S	160397
1600	35	5	3	T3	—	—	—	CB5A3A1P4	S	160400
1250	24	5	3-1/2	T3	CB5A3J1P1	S	160418	CB5A3J1P2	NS	160426
2200	38	5	4	T3	CB5A4A1P1	S	160434	CB5A4A1P2	S	160442
2750	32	5	6	T3	CB5A6A1P1	S	160450	CB5A6A1P2	S	160469
900	38	5-1/2	1-1/2	T2	CB5J1J1P1	S	160477	CB5J1J1P2	S	160485
1000	30	5-1/2	2	T2	CB5J2A1P1	S	160493	CB5J2A1P2	S	160506
1500	38	5-1/2	2-1/2	T2	—	—	—	CB5J2J1P1	S	160514
1200	25	5-1/2	3	T3	CB5J3A1P1	S	160522	CB5J3A1P2	S	160530
1550	25	5-1/2	4	T3	CB5J4A1P1	S	160549	CB5J4A1P2	S	160557
2000	24	5-1/2	5	T3	CB5J5A1P1	S	160565	CB5J5A1P2	S	160573
650	27	5-3/4	1-1/2	T2	—	—	—	CB5N1J1P1	S	160581
850	25	5-3/4	2	T2	CB5N2A1P1	S	160590	CB5N2A1P2	S	160602
1250	25	5-3/4	3	T3	CB5N3A1P1	S	160610	CB5N3A1P2	S	160629
1200	18	5-3/4	4	T3	CB5N4A1P1	S	160637	CB5N4A1P2	S	160645
1100	40	6	1-1/2	T2	—	—	—	CB6A1J1P1	S	160653
1000	28	6	2	T2	CB6A2A1P1	S	160661	CB6A2A1P2	S	160670
1500	35	6	2-1/2	T2	CB6A2J1P1	S	160709	CB6A2J1P2	S	160717
1600	29	6	3	T3	CB6A3A1P1	S	160725	CB6A3A1P2	S	160733
1450	21	6	4	T3	CB6A4A1P1	S	160741	CB6A4A1P2	S	160750
1800	20	6	5	T3	CB6A5A1P1	S	160768	CB6A5A1P2	S	160776
2000	22	6	5-1/2	T3	CB6A5J1P1	S	160784	CB6A5J1P2	S	160792
2000	19	6	6	T3	CB6A6A1P1	S	160805	CB6A6A1P2	S	160813
3000	28	6	6	T3	CB6A6A1P3	S	160821	CB6A6A1P4	S	160830

Note: For watt densities higher than 40 wpsi, consult factory.

Chromalox CB Ceramic Band Heaters

Specifications and Ordering Information

Watts	W/In ²	Dimensions (In.)		Terminal Type	120V			240V		
		I.D.	Width		Model	Stock	PCN	Model	Stock	PCN
1000	33	6-1/2	1-1/2	T2	CB6J1J1P1	S	160848	CB6J1J1P2	S	160856
1000	26	6-1/2	2	T2	CB6J2A1P1	S	160864	CB6J2A1P2	S	160872
1600	35	6-1/2	3	T3	—	—	—	CB6J3A1P1	S	160880
2500	26	6-1/2	5	T3	CB6J5A1P1	S	160899	CB6J5A1P2	S	160901
3000	24	6-1/2	6-1/2	T3	CB6J6J1P1	S	160910	CB6J6J1P2	S	160928
1000	31	6-3/4	1-1/2	T2	CB6N1J1P1	S	160936	CB6N1J1P2	S	160944
1250	36	6-3/4	2	T2	CB6N2A1P1	S	160952	CB6N2A1P2	S	160960
2000	25	6-3/4	4	T3	—	—	—	CB6N4A1P1	S	161605
3000	30	6-3/4	5	T3	CB6N5A1P1	S	160987	CB6N5A1P2	S	161613
3000	25	6-3/4	6	T3	—	—	—	CB6N6A1P1	S	161007
1700	38	7	2	T2	—	—	—	CB7A2A1P1	S	161023
2500	38	7	3	T3	—	—	—	CB7A311P1	S	161621
2600	32	7	4	T3	CB7A4A1P1	NS	161040	CB7A4A1P2	S	161648
3000	30	7	5	T3	CB7A5A1P1	NS	161066	CB7A5A1P2	S	161664
5000	40	7	6	T3	CB7A6A1P1	NS	161082	CB7A6A1P2	S	161090
1200	35	7-1/2	1-1/2	T2	—	—	—	CB7J1J1P1	S	161103
1500	35	7-1/2	2	T2	—	—	—	CB7J2A1P1	S	161672
1800	30	7-1/2	3	T3	—	—	—	CB7J3A1P2	S	161120
2000	20	7-1/2	4-1/2	T3	CB7J4J1P1	NS	161680	CB7J4J1P2	S	161146
3000	30	7-1/2	4-1/2	T3	—	—	—	CB7J4J1P3	S	161699
2500	22	7-1/2	5	T3	CB7J5A1P1	NS	161162	CB7J5A1P2	S	161701
3500	32	7-1/2	5	T3	—	—	—	CB7J5A1P3	S	161189
3500	33	7-1/2	5-1/2	T3	—	—	—	CB7J5J1P1	S	161728
4500	25	7-1/2	6	T3	—	—	—	CB7J8A1P1	S	161200
1250	33	8	1-1/2	T2	CB8A1J1P1	S	161218	CB8A1J1P2	S	161226
1500	21	8	2	T2	—	—	—	CB8A2A1P1	S	161744
2000	28	8	3	T3	CB8A3A1P1	NS	161242	CB8A3A1P2	S	161250
3000	30	8	4	T3	—	—	—	CB8A4A1P1	S	161269
3500	28	8	6	T3	—	—	—	CB8A6A1P1	S	161277
1500	39	8-1/2	1-1/2	T2	CB8J1J1P1	NS	161285	CB8J1J1P2	S	161752
1300	31	9	1-1/2	T2	CB9A1J1P1	NS	161322	CB9A1J1P2	NS	161330
1750	32	9	2	T2	CB9A2A1P1	NS	161349	CB9A2A1P2	NS	161779
2000	30	9	2-1/2	T2	CB9A2J1P1	NS	161365	CB9A2J1P2	NS	161373
2800	34	9	3	T3	—	—	—	CB9A3A1P1	NS	161381
2500	19	9	5	T3	—	—	—	CB9A5A1P1	NS	161787
3000	20	9	5-1/2	T3	—	—	—	CB9A5J1P1	NS	161402
2200	25	9-1/2	3	T3	—	—	—	CB9J3A1P1	NS	161795
4200	32	9-1/2	6	T3	—	—	—	CB9J6A1P1	NS	161429
2400	26	10	3	T3	—	—	—	CB10A3A1P1	NS	161808
3000	20	10	5	T3	—	—	—	CB10A5A1P1	NS	161445
3500	25	10	5-1/2	T3	—	—	—	CB10A5J1P1	NS	161461
2500	25	10-1/2	3	T3	—	—	—	CB10J3A1P1	NS	161470
4000	34	10-1/2	4-1/2	T3	—	—	—	CB10J4J1P1	NS	161488
2500	25	11	3	T3	—	—	—	CB11A3A1P1	NS	161496
4000	25	11	5	T3	CB11A5A1P1	NS	161509	CB11A5A1P2	NS	161824
4500	23	11	6	T3	—	—	—	CB11A6A1P1	NS	161525
2000	28	12	2	T2	—	—	—	CB12A2A1P1	NS	161533
2500	28	12	3	T3	—	—	—	CB12A3A1P1	NS	161541
4000	19	12	6	T3	CB12A6A1P1	NS	161832	CB12A6A1P2	NS	161568
5000	23	12	6	T3	CB12A6A1P3	NS	161576	CB12A6A1P4	NS	161584

Note: For watt densities higher than 40 wpsi, consult factory.