

TODAY HEATERS

Stock base Cartridge heaters
with lead adapter options to ship quickly

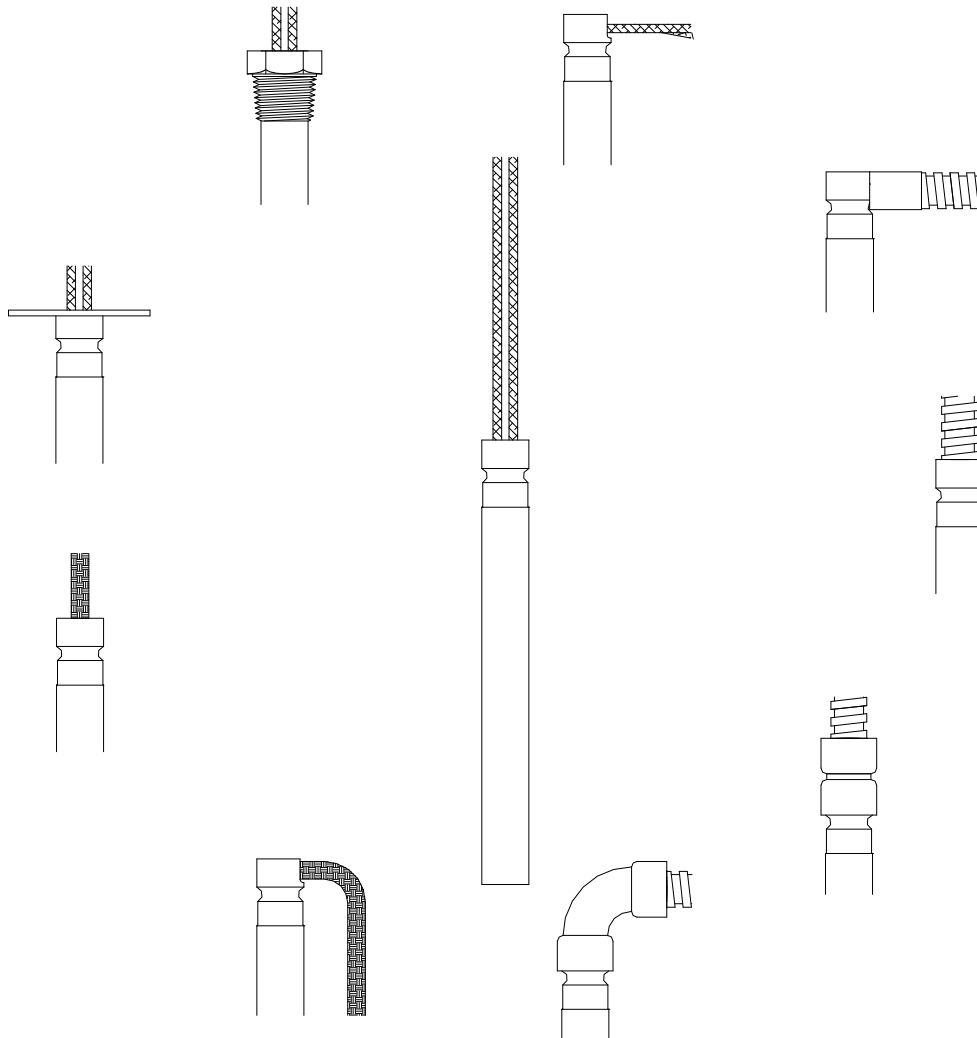

Cartridge heaters made exactly the way you want....shipped **TODAY**

What are you waiting for?

Heaters made your way...*TODAY*

Imagine choosing a cartridge heater to your exact specifications and having it ship the same day your order it! What once was impossible is a reality...*TODAY*. Introducing the Marathon *TODAY* heater. In stock, ready to ship *TODAY*, just the way you want it, with no rush charges. Why tie up your money in inventory when you can have the heater you need shipped *TODAY*.

Marathon *TODAY* heaters are offered with a variety of options

- Right angle leads
- Stainless steel braided leads
- Right angle stainless steel braided leads
- Copper elbow with stainless steel braided leads
- Copper coupler with stainless steel braided leads
- Stainless steel flexible conduit
- Right angle stainless steel flexible conduit
- Copper elbow with stainless steel flexible conduit
- Copper coupler with stainless steel flexible conduit
- Stainless steel NPT fitting
- Brass NPT fitting
- Stainless steel flange
- Epoxy potting
- Silicon Rubber Seal

All *TODAY* heaters have common dimensions regardless of the configuration.

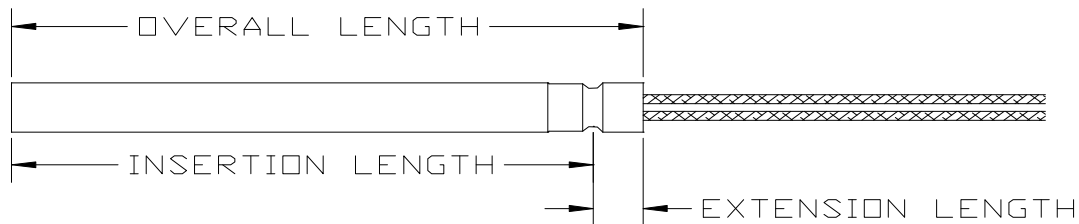

Heater Diameter	Extension Length	Lead Wire Gage	Lead Wire Rating
1/4	.25	24	250° C
5/16	.25	24	250° C
3/8	.31	22	550° C
1/2	.37	22	550° C
5/8	.37	18	550° C
3/4	.37	18	550° C

All heaters are available with 14", 26", or 38" swaged-in, stranded leads.

Heaters made your way...*TODAY*

Right Angle Construction

Right angle lead construction offers lead protection where leads might otherwise be bent at a sharp angle exiting the heater. The cap is seal welded to heater for contamination resistance. A protective sleeve covers the leads where they exit the heater to provide protection from metal edges and offer resistance to flexing. Right angle construction is available with standard leads, stainless steel braid over the leads, and stainless steel flexible conduit. Available with 14", 26", or 38" leads.

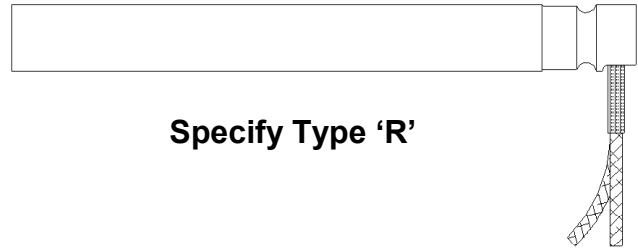

Specify Type 'R'

Stainless Steel Braid

Stainless steel braid offers excellent abrasion protection and flexibility. Stainless steel braid is not watertight and offers little resistance to crushing or sharp objects. Stainless steel braid is available straight out of the heater or can be combined with the right angle construction.

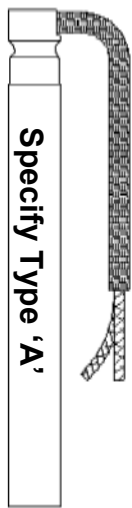

Specify Type 'A'



Specify Type 'B'

Heater Diameter	Braid Diameter	
	Straight Exit	Right Angle Construction
1/4	3/16"	3/16"
5/16	3/16"	3/16"
3/8	1/4"	1/4"
1/2	1/4"	1/4"
5/8	1/4"	1/4"
3/4	1/4"	1/4"

Available lead lengths are 14", 26", and 38". Available braid lengths are 12", 24", and 36".

Stainless Steel Flexible Conduit

Stainless steel flexible conduit offers the best abrasion resistance and good resistance to crushing. Stainless steel conduit is not watertight. Stainless steel flexible conduit is often referred to as armor or hose.

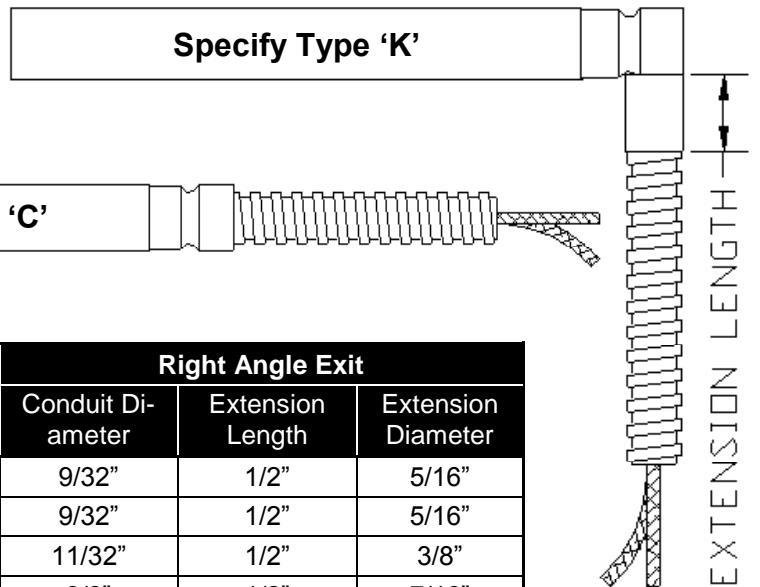

Specify Type 'K'

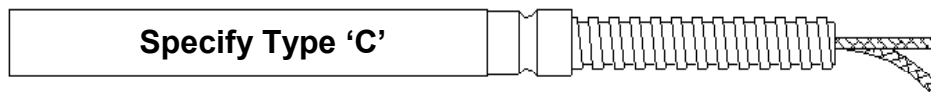

Specify Type 'C'

Heater Diameter	Straight Exit	Right Angle Exit		
	Conduit Diameter	Conduit Diameter	Extension Length	Extension Diameter
1/4	7/32"	9/32"	1/2"	5/16"
5/16	7/32"	9/32"	1/2"	5/16"
3/8	7/32"	11/32"	1/2"	3/8"
1/2	9/32"	3/8"	1/2"	7/16"
5/8	3/8"	3/8"	1/2"	7/16"
3/4	1/2"	3/8"	1/2"	7/16"

Available lead lengths are 14", 26", and 38". Available conduit lengths are 12", 24" and 36"

Heaters made your way...*TODAY*

NPT Fittings

NPT fittings are available in both brass and stainless steel. Please note that Marathon *Today* heaters have a 304SS sheath. It is important to check compatibility with any fluids in which the heaters may be immersed. Fittings can be installed on heaters with braid or stainless steel flexible conduit. Heater cavities can be potted for extra moisture resistance.

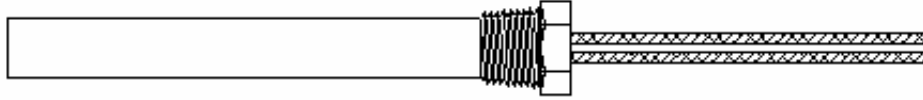

Heater Diameter	Standard Fitting		
	NPT Size	Fitting Length (Overall)	Hex Size
1/4	1/8	.56	7/16"
5/16	1/4	.66	9/16"
3/8	1/4	.66	9/16"
1/2	3/8	.77	11/16"
5/8	1/2	.84	7/8"
3/4	3/4	.93	1-1/6"
For Brass Fitting, specify type 'H'			
For Stainless Steel Fitting, specify type 'Q'			

Heater Diameter	Oversize Fitting		
	NPT Size	Fitting Length (Overall)	Hex Size
1/4	1/4	.66	9/16"
5/16	3/8	.77	11/16"
3/8	3/8	.77	11/16"
1/2	1/2	.84	7/8"
5/8	3/4	.93	1-1/6"
3/4	1	1.34	1-5/16"
For Brass Fitting, specify type 'HH'			
For Stainless Steel Fitting, specify type 'QQ'			

Stainless Steel Flange

Flanges can offer a means of holding the heater in place to prevent backing out during operation. Flanges can also aid in heater removal. Flanges are TIG welded for a complete seal. Flanges are .062 thick. Fittings can be installed on heaters with braid or stainless steel flexible conduit. Heater cavities can be potted for extra moisture resistance.

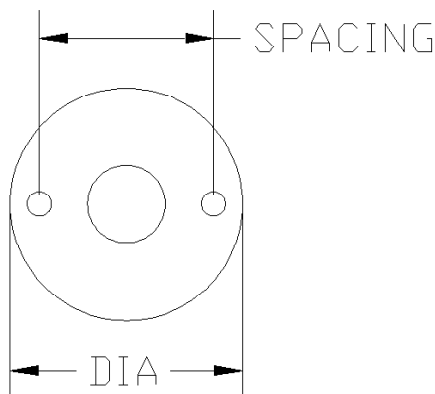
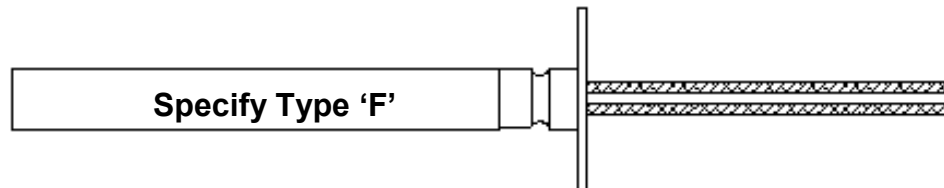

Heater Diameter	Flange OD		
	1"	1-1/2"	2"
Hole Spacing	.75	1.125	1.5
Mtg.Hole Dia.	.144	.156	.201
1/4	yes	yes	no
5/16	yes	yes	no
3/8	yes	yes	no
1/2	yes	yes	yes
5/8	no	yes	yes
3/4	no	yes	yes

Order it today...it ships *TODAY*

Heaters made your way...*TODAY*

Potting

Several potting compounds are available for *Today* heaters. Potting compounds are available for protection from moisture and contamination. Often times potting is used in conjunction with sleeving where the leads exit the heater to provide a strain relief for the leads. Please note that due to cure times, most type of potting can not ship the same day as ordered.

	Potting Type			
	Silicon Rubber	Epoxy	EpoxyLite	Cement
Ship Time	Next Day	Same Day	Next Day	Next Day
Max Temp	500°F	265°F	650°F	1800°F
Moisture Protection	Excellent	Good	Very Good	Poor
Contamination Protection	Excellent	Good	Very Good	Fair
Mechanical Strength	Fair	Excellent	Excellent	Good
Vibration Resistance	Excellent	Excellent	Excellent	Poor
When ordering specify	Type 'V'	Type 'E'	Type 'EX'	Type 'P'

Copper Elbow

Copper elbows are normally used in conjunction with stainless steel flexible conduit. But, they can also be used with stainless steel braid or regular leads when potting is desired in a right angle configuration. They are also better than standard right angle construction in applications with a lot of flexing.

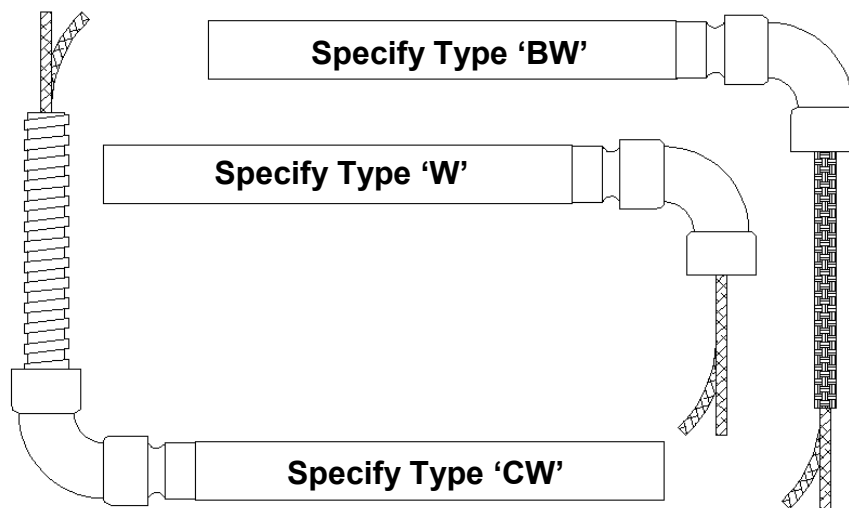

Copper Coupler

Copper couplers are another means of attaching stainless steel flexible conduit to heaters.

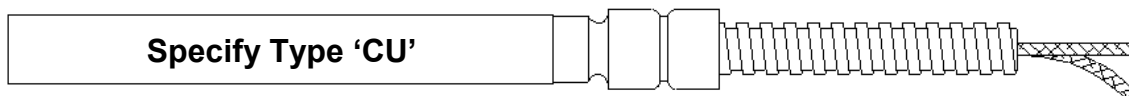

Order it today...it ships *TODAY*

Heaters made your way...*TODAY*

Convolved Tubing

Convolved tubing offers a completely watertight and contamination proof method of protecting the leads. Convolved tubing is stiffer than flexible conduit and has a larger bend radius. Convolved tubing is only available for 1/2", 5/8" and 3/4" heaters. Convolved tubing is available in 12", 24", and 36" lengths in both straight and right angle construction.

Convolved Tubing Material	321 SS
Tubing OD	.50"
Tubing ID	.25"
Min Bend Radius (No Movement)	1"
Min Bend Radius (Flexing)	5"

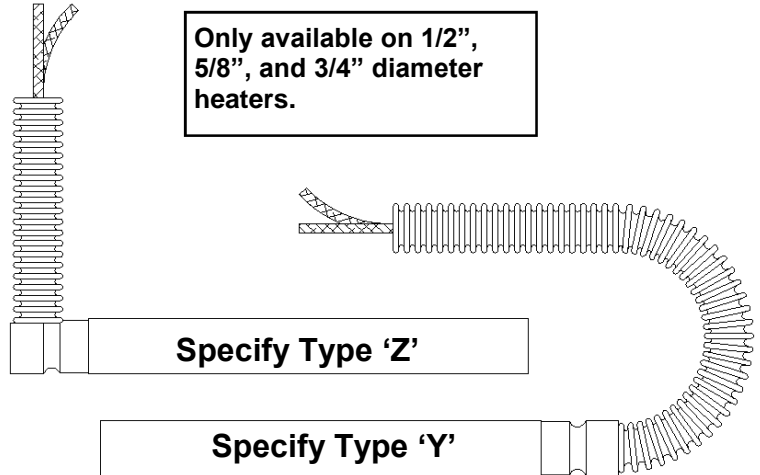

How to Order

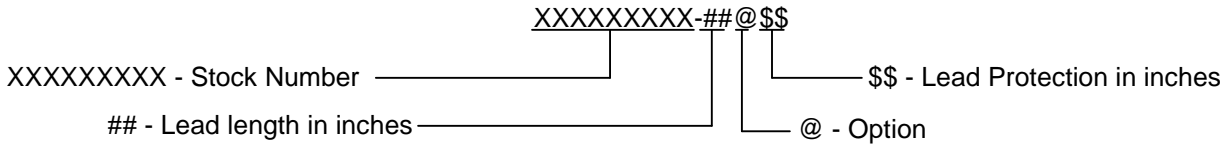

Examples:

- **TD37060Z-14A12**; 3/8 x 6, 120V 200W with 14" leads, and 12" right angle braid
- **TD50050AH-26EH**; 1/2 x 5, 120V 350W with 26" leads, brass 3/8 NPT fitting, and epoxy potting
- **TD75120D-36BQQ24**; 3/4 x 12, 240V 1500W with 38" leads, stainless steel 1" NPT fitting, and 24" stainless steel braid

*When there is more than one option added to the heater, the option codes are always listed alphabetically

Too confusing? Just tell us what you want and we'll give you the part number.

Option	Code
Right Angle Leads	R
Stainless Steel Braid	B
Right Angle St. Steel Braid	A
Flexible Conduit	C
Right Angle Flexible Conduit	K
Standard Brass NPT	H
Oversize Brass NPT	HH
Standard Stainless NPT	Q
Oversize Stainless NPT	QQ
Standard Flange	F
Oversize Flange	FF
Epoxy Potting	E
Epoxy Potting	X
Silicon Rubber Potting	V
Cement Potting	P
Convolved Tubing	Y
Right Angle Convolved Tubing	Z
Copper Elbow	W
Copper Coupler	U

Diameter	Insertion Length	O.A.L.	Heated Length	Watts	Watt Density	120 V	240 V
1/4	1	1.25		55		TD25010A	—
1/4	1	1.25		100		TD25010B	TD25010C
1/4	1.25	1.50		75		TD25012A	—
1/4	1.50	1.75		50		TD25015B	—
1/4	1.50	1.75		100		TD25015C	—
1/4	1.50	1.75		150		TD25015D	TD25015E
1/4	1.50	1.75		200		TD25015F	TD25015B
1/4	2	2.25		50		TD25020A	—
1/4	2	2.25		100		TD25020B	—
1/4	2	2.25		150		TD25020C	TD25020D
1/4	2	2.25		200		TD25020E	TD25020A
1/4	2	2.25		250		TD25020G	TD25020H
1/4	2.5	2.75		200		TD25025A	TD25025B
1/4	3	3.25		75		TD25030A	—
1/4	3	3.25		150		TD25030B	—
1/4	3	3.25		200		TD25030C	TD25030D
1/4	3	3.25		300		TD25030E	TD25030A
1/4	4	4.25		100		TD25040A	—
1/4	4	4.25		200		TD25040B	TD25040C
1/4	4	4.25		300		TD25040D	TD25040E
1/4	4	4.25		400		TD25040F	TD25040A
1/4	4.5	4.75		200		TD25045A	—
1/4	5	5.25		125		TD25050A	—
1/4	5	5.25		300		TD25050B	—
1/4	5	5.25		500		TD25050C	TD25050A
1/4	6	6.25		150		TD25060A	TD25060B
1/4	6	6.25		600		TD25060C	TD25060A
1/4	7	7.25		300		TD25070A	TD25070B
1/4	8	8.25		400		TD25080A	TD25080B
1/4	10	10.25		500		—	TD25100A
1/4	12	12.25		500		—	TD25120A
3/8	1	1.31		100		—	TD37010A
3/8	1.25	1.56		100		—	TD37012A
3/8	1.25	1.56		150		—	TD37012B
3/8	1.50	1.81		50		TD37015A	—
3/8	1.50	1.81		100		TD37015B	TD37015C
3/8	1.50	1.81		150		TD37015D	TD37015E
3/8	1.50	1.81		200		TD37015F	TD37015A
3/8	1.50	1.81		250		TD37015H	TD37015J
3/8	1.75	2.06		50		TD37017A	—
3/8	1.75	2.06		200		—	TD37017A
3/8	2	2.31		50		TD37020A	—
3/8	2	2.31		75		TD37020B	—
3/8	2	2.31		100		TD37020C	TD37020D
3/8	2	2.31		150		TD37020E	TD37020F
3/8	2	2.31		200		TD37020G	TD37020A
3/8	2	2.31		250		TD37020M	TD37020J
3/8	2	2.31		300		TD37020K	TD37020B
3/8	2.5	2.81		250		TD37025A	TD37025B
3/8	3	3.31		100		TD37030A	—
3/8	3	3.31		125		TD37030B	—
3/8	3	3.31		150		TD37030K	TD37030L
3/8	3	3.31		200		TD37030C	TD37030D
3/8	3	3.31		250		TD37030E	TD37030F
3/8	3	3.31		300		TD37030G	TD37030H
3/8	3	3.31		400		TD37030J	TD37030A
3/8	3	3.31		500		TD37030L	TD37030B
3/8	3.5	3.81		75		TD37035A	—
3/8	3.5	3.81		125		TD37035D	—
3/8	3.5	3.81		300		TD37035B	TD37035A
3/8	3.5	3.81		500		TD37035C	TD37035D
3/8	4	4.31		125		TD37030A	—
3/8	4	4.31		150		TD37030B	TD37030H
3/8	4	4.31		250		TD37030C	TD37030D
3/8	4	4.31		400		TD37030E	TD37030F
3/8	4	4.31		500		TD37030G	TD37030A
3/8	4	4.31		600		—	TD37030B

More 3/8" diameter heaters on the next page.



Diameter	Insertion Length	O.A.L.	Heated Length	Watts	Watt Density	120 V	240 V
3/8	4.5	4.81		125		TD37045A	—
3/8	4.5	4.81		300		TD37045B	—
3/8	4.5	4.81		500		TD37045C	TD37045A
3/8	5	5.31		100		TD37050E	—
3/8	5	5.31		125		TD37050N	—
3/8	5	5.31		150		TD37050B	TD37050J
3/8	5	5.31		200		TD37050H	—
3/8	5	5.31		250		TD37050C	—
3/8	5	5.31		300		TD37050K	TD37050L
3/8	5	5.31		400		TD37050D	TD37050E
3/8	5	5.31		500		TD37050M	TD37050N
3/8	5	5.31		600		TD37050F	TD37050B
3/8	5	5.31		800		—	TD37050H
3/8	5	5.31		1000		—	TD37050C
3/8	6	6.31		100		TD37060E	—
3/8	6	6.31		125		TD37060K	—
3/8	6	6.31		150		TD37060A	—
3/8	6	6.31		200		TD37060B	—
3/8	6	6.31		250		TD37060C	TD37060F
3/8	6	6.31		300		TD37060G	TD37060H
3/8	6	6.31		400		TD37060D	TD37060E
3/8	6	6.31		500		TD37060J	TD37060K
3/8	6	6.31		600		—	TD37060A
3/8	6	6.31		800		—	TD37060B
3/8	6	6.31		1000		—	TD37060C
3/8	6.5	6.81		500		TD37065A	TD37065B
3/8	7	7.31		250		TD37070A	—
3/8	7	7.31		400		TD37070B	TD37070C
3/8	7	7.31		500		TD37070D	TD37070E
3/8	7	7.31		600		TD37070F	TD37070G
3/8	7	7.31		1000		—	TD37070A
3/8	7.5	7.81		500		—	TD37075A
3/8	8	8.31		250		TD37080A	—
3/8	8	8.31		300		TD37080C	TD37080D
3/8	8	8.31		500		TD37080E	TD37080F
3/8	8	8.31		600		TD37060H	TD37080B
3/8	8	8.31		750		—	TD37080G
3/8	8	8.31		1000		—	TD37080A
3/8	9	9.31		250		TD37090A	—
3/8	9	9.31		400		TD37090B	TD37090C
3/8	9	9.31		1000		—	TD37090A
3/8	10	10.31		250		TD37100A	—
3/8	10	10.31		400		TD37100C	—
3/8	10	10.31		600		TD37100D	TD37100B
3/8	10	10.31		1000		—	TD37100A
3/8	11	11.31		1000		—	TD37110A
3/8	12	12.31		250		TD37120A	—
3/8	12	12.31		500		TD37120D	TD370120E
3/8	12	12.31		600		TD370120F	TD37120B
3/8	12	12.31		750		—	TD370120G
3/8	12	12.31		1000		—	TD37120A
3/8	12	12.31		1500		—	TD37120C
3/8	14	14.31		600		—	TD37140A
3/8	14	14.31		1000		—	TD37140B
3/8	15	15.31		1000		—	TD37150A
3/8	16	16.31		1000		—	TD37160A
3/8	21	21.31		1000		—	TD37210A

More 3/8" diameter heaters on the previous page.

Diameter	Insertion Length	O.A.L.	Heated Length	Watts	Watt Density	120 V	240 V
1/2	1.50	1.87		50		TD50015A	—
1/2	1.50	1.87		200		TD50015B	TD50015A
1/2	2	2.37		75		TD50020A	—
1/2	2	2.37		100		TD50020B	—
1/2	2	2.37		200		—	TD50020C
1/2	2	2.37		300		—	TD50020A
1/2	2	2.37		400		—	TD50020B
1/2	2.50	2.87		75		TD50025A	—
1/2	2.50	2.87		100		TD50025B	—
1/2	2.50	2.87		125		TD50025C	—
1/2	2.50	2.87		300		—	TD50025A
1/2	2.50	2.87		400		—	TD50025B
1/2	2.50	2.87		500		—	TD50025C
1/2	3	3.37		100		TD50030F	—
1/2	3	3.37		125		TD50030A	TD50030A
1/2	3	3.37		250		TD50030B	TD50030C
1/2	3	3.37		300		TD50030H	TD50030D
1/2	3	3.37		400		TD50030E	TD50030F
1/2	3	3.37		500		TD50030J	TD50030A
1/2	3.5	3.87		125		TD50035A	—
1/2	3.5	3.87		250		—	TD50035B
1/2	3.5	3.87		400		—	TD50035C
1/2	3.5	3.87		500		—	TD50035A
1/2	3.5	3.87		750		—	TD50035D
1/2	4	4.37		125		—	TD50040A
1/2	4	4.37		150		TD50040M	—
1/2	4	4.37		200		TD50040J	—
1/2	4	4.37		250		TD50040K	TD50040B
1/2	4	4.37		300		TD50040C	TD50040D
1/2	4	4.37		400		TD50040E	TD50040F
1/2	4	4.37		500		TD50040L	TD50040G
1/2	4	4.37		600		—	TD50040M
1/2	4	4.37		750		—	TD50040H
1/2	4	4.37		800		—	TD50040J
1/2	4	4.37		1000		—	TD50040K
1/2	4.5	4.87		125		TD50045C	—
1/2	4.5	4.87		175		TD50045B	—
1/2	4.5	4.87		250		—	TD50045A
1/2	4.5	4.87		500		—	TD50045C
1/2	4.5	4.87		750		—	TD50045B
1/2	5	5.37		200		TD37050A	—
1/2	5	5.37		250		TD50050B	TD50050F
1/2	5	5.37		300		—	TD50050C
1/2	5	5.37		500		TD50050D	TD50050E
1/2	5	5.37		800		—	TD50050A
1/2	5	5.37		1000		—	TD50050B
1/2	5.5	5.87		500		—	TD50055B
1/2	5.5	5.87		750		—	TD50055A
1/2	6	6.37		250		TD50060D	TD50060E
1/2	6	6.37		300		TD50060G	TD50060H
1/2	6	6.37		375		TD50060A	—
1/2	6	6.37		400		—	TD50060J
1/2	6	6.37		500		TD50060K	TD50060B
1/2	6	6.37		750		—	TD50060C
1/2	6	6.37		1000		TD50060F	TD50060D
1/2	6	6.37		1200		—	TD50060G
1/2	6	6.37		1500		—	TD50060A

More 1/2" diameter heaters on the next page.

Diameter	Insertion Length	O.A.L.	Heated Length	Watts	Watt Density	120 V	240 V	480 V
1/2	6.5	6.87		250		TD50065A	—	—
1/2	6.5	6.87		500		—	TD50065B	—
1/2	6.5	6.87		1000		—	TD50065A	—
1/2	7	7.37		250		TD50070A	—	—
1/2	7	7.37		300		—	TD50070D	—
1/2	7	7.37		500		TD50070E	TD50070F	—
1/2	7	7.37		600		TD50070B	TD50070C	—
1/2	7	7.37		750		—	TD50070G	—
1/2	7	7.37		1000		—	TD50070A	—
1/2	7.5	7.87		1000		—	TD50075A	—
1/2	8	8.37		250		TD50080G	TD50080K	—
1/2	8	8.37		300		TD50080H	—	—
1/2	8	8.37		375		TD50080A	—	—
1/2	8	8.37		400		—	TD50080B	—
1/2	8	8.37		500		TD50080J	TD50080C	—
1/2	8	8.37		750		TD50080D	TD50080E	—
1/2	8	8.37		1000		TD50080F	TD50080G	TD50080K
1/2	8	8.37		1200		—	TD50080H	—
1/2	8	8.37		1500		—	TD50080A	—
1/2	8	8.37		2000		—	TD50080J	—
1/2	8.5	8.87		500		—	TD50085A	—
1/2	8.5	8.87		1000		—	TD50085B	—
1/2	9	9.37		500		—	TD50090A	—
1/2	9	9.37		1000		—	TD50090B	—
1/2	9.5	9.87		1000		—	TD50095A	—
1/2	10	10.37		500		TD50100A	TD50100B	—
1/2	10	10.37		600		—	TD50100F	—
1/2	10	10.37		1000		TD50100C	TD50100D	TD50100G
1/2	10	10.37		1500		—	TD50100E	—
1/2	10	10.37		2000		—	TD50100A	TD50100H
1/2	11	11.37		1000		—	TD50110A	—
1/2	11	11.37		1600		—	TD50110B	—
1/2	12	12.37		500		TD50120A	TD50120E	—
1/2	12	12.37		600		TD50120F	TD50120B	—
1/2	12	12.37		800		—	TD50120G	—
1/2	12	12.37		1000		TD50120H	TD50120C	—
1/2	12	12.37		1200		—	—	TD50120J
1/2	12	12.37		1500		—	TD50120D	—
1/2	12	12.37		2000		—	TD50120A	—
1/2	12	12.37		2400		—	TD50120F	—
1/2	12.5	12.87		1000		—	TD50125A	—
1/2	13	13.37		1000		—	TD50130A	—
1/2	14	14.37		1000		TD50140A	TD50140B	—
1/2	14	14.37		2300		—	TD50140C	—
1/2	15	15.37		1000		—	TD50150A	—
1/2	15	15.37		1000		—	TD50150A	—
1/2	15	15.37		1500		—	TD50150B	—
1/2	15	15.37		2000		—	TD50150C	—
1/2	16	16.37		800		TD50160A	TD50160B	—
1/2	16	16.37		1000		—	TD50160C	—
1/2	16	16.37		1500		—	TD50160D	—
1/2	16	16.37		2000		—	TD50160E	—
1/2	18	18.37		1000		—	TD50180A	—
1/2	18	18.37		1500		—	TD50180C	TD50180B
1/2	20	20.37		1000		—	TD50200A	—
1/2	20	20.37		1500		—	TD50200B	—
1/2	24	24.37		1000		—	TD50240A	—
1/2	24	24.37		2000		—	TD50240B	—

More 1/2" diameter heaters on the previous page.

Diameter	Insertion Length	O.A.L.	Heated Length	Watts	Watt Density	120 V	240 V	480 V
5/8	3	3.37		250		—	TD62030A	—
5/8	3	3.37		400		—	TD62030B	—
5/8	3	3.37		500		TD62030D	TD62030C	—
5/8	4	4.37		250		TD62040A	—	—
5/8	4	4.37		500		—	TD62040B	—
5/8	4	4.37		750		—	TD62040C	—
5/8	4	4.37		1000		—	TD62040A	—
5/8	5	5.37		250		TD62050A	—	—
5/8	5	5.37		500		—	TD62050B	—
5/8	5	5.37		750		—	TD62050C	—
5/8	5	5.37		1000		—	TD62050A	—
5/8	6	6.37		250		TD62060A	—	—
5/8	6	6.37		375		TD62060D	—	—
5/8	6	6.37		500		TD62060F	TD62060B	—
5/8	6	6.37		750		TD62060G	TD62060C	—
5/8	6	6.37		1000		—	TD62060A	—
5/8	6	6.37		1500		—	TD62060D	—
5/8	7	7.37		375		TD62070A	—	—
5/8	7	7.37		500		—	TD62070C	—
5/8	7	7.37		1000		—	TD62070B	—
5/8	7	7.37		1500		—	TD62070A	—
5/8	8	8.37		375		TD62080C	—	—
5/8	8	8.37		500		TD62080D	TD62080A	—
5/8	8	8.37		750		—	TD62080E	—
5/8	8	8.37		1000		—	TD62080B	—
5/8	8	8.37		1500		—	TD62080C	—
5/8	8	8.37		2000		—	TD62080D	—
5/8	9	9.37		1000		—	TD62090A	—
5/8	9	9.37		1500		—	TD62090B	—
5/8	10	10.37		500		TD62100A	TD62100E	—
5/8	10	10.37		650		—	TD62100B	—
5/8	10	10.37		750		—	TD62100F	—
5/8	10	10.37		1000		—	TD62100C	—
5/8	10	10.37		1500		—	TD62100D	—
5/8	10	10.37		2000		—	TD62100A	—
5/8	11	11.37		1000		—	TD62110A	—
5/8	12	12.37		500		TD62120C	TD62120D	—
5/8	12	12.37		1000		—	TD62120A	—
5/8	12	12.37		1500		—	TD62120B	TD62120E
5/8	12	12.37		2000		—	TD62120C	TD62120D
5/8	13	13.37		1000		—	TD62130A	—
5/8	14	14.37		500		TD62140C	—	—
5/8	14	14.37		1000		—	TD62140A	—
5/8	14	14.37		1500		—	TD62140B	—
5/8	14	14.37		2000		—	TD62140C	—
5/8	15	15.37		500		TD62150A	—	—
5/8	15	15.37		600		TD62150B	—	—
5/8	15	15.37		750		—	TD62150C	—
5/8	15	15.37		1000		—	TD62150D	—
5/8	15	15.37		2000		—	TD62150A	—
5/8	15	15.37		2400		—	TD62150B	—
5/8	16	16.37		500		TD62160B	—	—
5/8	16	16.37		625		TD62160C	—	—
5/8	16	16.37		1000		—	TD62160A	—
5/8	16	16.37		1125		TD62160D	—	—
5/8	16	16.37		2000		—	TD62160B	—
5/8	16	16.37		2500		—	TD62160C	—
5/8	16	16.37		4500		—	TD62160D	—
5/8	18	18.37		750		TD62180A	—	—
5/8	18	18.37		1000		—	TD62180B	—
5/8	18	18.37		1500		—	TD62180C	—
5/8	18	18.37		3000		—	TD62180A	—
5/8	20	20.37		875		TD62200A	—	—
5/8	20	20.37		1500		—	TD62200B	—
5/8	20	20.37		3500		—	TD62200A	—
5/8	24	24.37		500		TD62240C	TD62240D	—
5/8	24	24.37		1000		—	TD62240A	—
5/8	24	24.37		1500		—	TD62240B	—
5/8	24	24.37		2000		—	TD62240C	TD62240D
5/8	30	30.37		1500		—	TD62300A	TD62300B
5/8	32	32.37		2000		—	TD623200A	—

Diameter	Insertion Length	O.A.L.	Heated Length	Watts	Watt Density	120 V	240 V	480 V
3/4	2	2.37		250		—	TD75020A	—
3/4	3	3.37		225		—	TD75030A	—
3/4	3	3.37		400		—	TD75030B	—
3/4	3	3.37		500		TD75030C	TD75030D	—
3/4	4	4.37		250		TD75040B	—	—
3/4	4	4.37		750		—	TD75040A	—
3/4	4	4.37		1000		—	TD75040B	—
3/4	5	5.37		250		TD75050B	—	—
3/4	5	5.37		500		—	TD75050A	—
3/4	5	5.37		1000		—	TD75050B	—
3/4	6	6.37		375		TD75060E	—	—
3/4	6	6.37		500		TD75060A	TD75060B	—
3/4	6	6.37		1000		—	TD75060C	—
3/4	6	6.37		1200		—	TD75060D	—
3/4	6	6.37		1500		—	TD75060E	—
3/4	6	6.37		2000		—	TD75060A	—
3/4	7	7.37		375		TD75070C	—	—
3/4	7	7.37		500		—	TD75070A	—
3/4	7	7.37		1000		—	TD75070B	—
3/4	7	7.37		1500		—	TD75070C	—
3/4	8	8.37		350		TD75080C	TD75080E	—
3/4	8	8.37		500		TD75080D	—	—
3/4	8	8.37		600		—	TD75080A	—
3/4	8	8.37		750		—	TD75080F	—
3/4	8	8.37		1000		—	TD75080B	—
3/4	8	8.37		1500		—	TD75080C	TD75080E
3/4	8	8.37		2000		—	TD75080D	—
3/4	9	9.37		350		TD75090D	TD75090B	—
3/4	9	9.37		1000		—	TD75090C	—
3/4	9	9.37		1400		—	TD75090D	TD37090B
3/4	9	9.37		1800		—	TD75090A	—
3/4	10	10.37		500		TD75100C	—	—
3/4	10	10.37		750		TD75100F	—	—
3/4	10	10.37		1000		—	TD75100A	—
3/4	10	10.37		1200		—	TD75100E	—
3/4	10	10.37		1500		—	TD75100B	—
3/4	10	10.37		2000		—	TD75100C	—
3/4	10	10.37		3000		—	TD75100F	—
3/4	12	12.37		500		TD75120D	TD75120E	—
3/4	12	12.37		1000		TD75120A	TD75120B	—
3/4	12	12.37		1500		—	TD75120C	—
3/4	12	12.37		2000		—	TD75120D	TD75120E
3/4	12	12.37		2500		—	TD75120F	—
3/4	14	14.37		2000		—	TD75140A	—
3/4	14	14.37		4500		—	TD75140B	—
3/4	15	15.37		1000		—	TD75150A	—
3/4	16	16.37		875		—	TD75160B	—
3/4	16	16.37		1000		—	TD75160C	—
3/4	16	16.37		1600		—	TD75160A	—
3/4	16	16.37		3500		—	—	TD75160B
3/4	18	18.37		1000		—	TD75180A	—
3/4	18	18.37		2000		—	TD75180B	TD75180C
3/4	18	18.37		2400		—	TD75180D	—
3/4	20	20.37		1200		—	TD75200A	—
3/4	20	20.37		2250		—	TD75200B	—
3/4	24	24.37		1000		—	TD75240A	—
3/4	24	24.37		1500		—	TD75240B	—
3/4	24	24.37		2000		—	TD75240C	—
3/4	24	24.37		2500		—	—	TD75240D
3/4	24	24.37		3000		—	TD75240E	—
3/4	24	24.37		4000		—	—	TD75240A
3/4	28	28.37		2400		—	TD75280A	—
3/4	30	30.37		2000		—	TD75300A	—
3/4	32	32.37		2000		—	TD75320A	—
3/4	36	36.37		2000		—	TD75360A	—