

## GTD 25 / 40A

POWER SOLID STATE RELAYS WITH LOGIC CONTROL AND DIAGNOSTICS



### Main applications

- Plastics extrusion lines and injection moulding machines
- Packing and packaging machines
- Polymerization plant for synthetic fibre production
- Chemical and pharmaceutical industries
- Industrial electric ovens
- Food processing plants

### Main features

- AC power solid state relays with logic signal control
- Switching at voltage zero crossing
- Built-in heatsink
- Rated current: 25Arms, 40Arms
- Non-repetitive voltage: 1200 Vp
- Rated voltage: up to 530VArms
- Input control range: 5...30 Vdc
- Optical isolation: 4000Vrms (input/output)
- Built-in HB diagnostics (partial heater break, junction in short circuit)
- Overheat protection (optional)
- 2-color control signal LED in input/alarm state
- On-board MOV (varistor)
- DIN rail or panel mounting (optional)

### PROFILE

The GTD series of power solid state relays (zero crossing type) are solid state actuators with built-in heatsink, heater break diagnostics (Hb function), selectable current scale, and adjustable setpoint.

Junction overheat protection is available as an option.

An alarm signal is provided in output.

The GTD series of power solid state relays are offered with currents of 25A and 40A, rated voltage 480 VAC, and Vdc input control signal.

Voltage transistors are protected by MOV (varistor).

All models are designed to guarantee performance at rated currents, with continuous power conduction at 40°C. See the dissipation curves for other performance conditions.

Thanks to their high performance, they are appropriate for very short switching times, with millions of operations without wear on components.

Various accessories are available, such as a front panel attachment, fuses and fuse holders.

### TECHNICAL DATA

#### General features

Category of use: AC1  
 Nominal voltage: 480Vac (max. range 48...530Vac)  
 Nominal frequency: 50/60Hz  
 Non-repetitive voltage: 1200Vac  
 Zero switching voltage: < 20V  
 Activation time: =1/2 cycle  
 Deactivation time: =1/2 cycle  
 Voltage drop at nominal current: = 1,4Vrms  
 Power factor = 1

#### Control inputs

Max. input: < 5mA@30V  
 Max. reverse voltage: 36Vdc  
 Control voltage: 5...30Vdc  
 Activation voltage: > 4,25Vdc  
 Deactivation voltage: < 3Vdc

#### Power supply

Vs = 20...30Vdc ±10%  
 Input 30mA at 30Vdc

#### Outputs

##### GTD 25

Nominal current: 25A@40°C in continuous service  
 Non-repetitive overcurrent t=20ms: 400A  
 I²t for blowout: 645A²s  
 dV/dt critical with output deactivated: 1000V/μs

##### GTD 40

Nominal current: 40A@40°C in continuous service  
 Non-repetitive overcurrent t=20ms: 600A  
 I²t for blowout: 1010A²s  
 dV/dt critical with output deactivated: 1000V/μs

### DIAGNOSTICS

#### Heater break Alarm (Hb)

Checks load by measuring current inside the device.

Current full scale is selectable: 5, 10, 15, 20, 25, 30, 35, 40A.

The alarm setpoint can be set at 10 levels within the selected scale.

#### Overtemperature alarm (optional)

Provides protection against junction overtemperature in "or" with the Hb alarm.

#### Alarm output

The alarm output is PNP type (not protected against short circuit) (output voltage = Vs - 0.7Vdc, Rout = 82Ω, Iout max. = 20mA)  
 The alarm is signaled by a yellow LED.

#### Isolation

Rated isolation voltage for power control/output: 4000VACrms

### Ambient conditions

- Working temperature: 0 to 80°C (see the dissipation curves)
- Max. relative humidity: 50%...40°C
- Max. installation altitude: 2000m asl
- Pollution level: 3
- Storage temperature: -20...85°C
- Max. air surrounding: 40°C

### Installation notes

Use the high-speed fuse specified in the catalog according to the connection example given.

Applications with solid state relays must provide an automatic safety switch to cut power to the load.

In order to obtain best reliability, it is important to install a heatsink correctly inside the panel, to reach an adequate thermal exchange between the device

and the surrounding air in natural convection conditions.

Mount it vertically (max. 10° inclination from the vertical axis)

- Vertical distance between a device and the panel walls >100mm
- Horizontal distance between a device and the panel walls: at least 20mm
- Vertical distance between devices: at least 300mm.
- Horizontal distance between devices: at least 20 mm. Make sure that the wire raceways do not reduce such distances: if they do, install the groups cantilevered to the panel so that air can flow vertically over the heat sink without obstructions.

### Limits of use

- Dissipation of thermic power on the device with restraints on the ambient temperature of the installation.
- Equip the cabinet with an external air

change or air-condition it, to put out dissipated power.

- Installation restraints (distances to be respected to grant dissipation with natural convection).
- Line transistor max. voltage and derivative limits, for which the power solid state relay is equipped with inside safety devices (based on the models).
- Leakage current < 3mA (max. value with rated voltage and junction temperature of 125°C).

## FACEPLATE DESCRIPTION

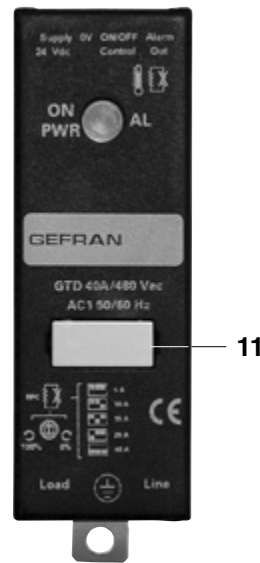
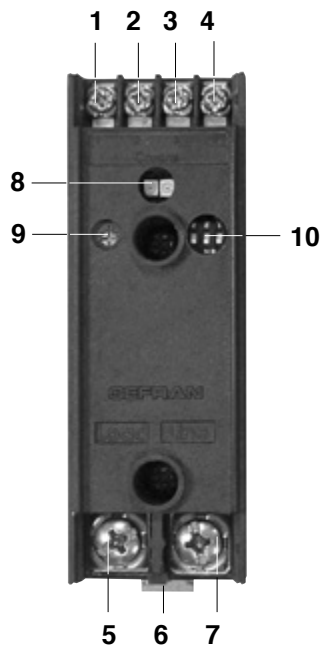

- 1: Aux. power supply 24Vdc (Vs)
- 2: Common (0V)
- 3: Control signal (+)
- 4: Alarm output
- 5: Load terminal
- 6: Ground terminal
- 7: Line terminal
- 8: 2-color signal LED (red/yellow)
- 9: Internal trimmer to set Hb diagnostics setpoint
- 10: Dip switch to select Hb diagnostics scale
- 11: LAB-1 relay ID label

## HEATER BREAK (Hb) ALARM FUNCTION

The heater break (Hb) alarm function lets the instrument diagnose a drop in load current (I<sub>l</sub>) below a settable limit (I<sub>t</sub>) during operation.

The unit in short circuit is also diagnosed by monitoring any current conducted in the absence of the control signal.

### Setting the alarm

The full scale (maximum value) of the limit is set with the dip switches located under the instrument cover.

With the single-turn trimmer, you can shift the set point from 0% (turning the trimmer clockwise) to 100% (turning the trimmer counterclockwise) on the set full scale.

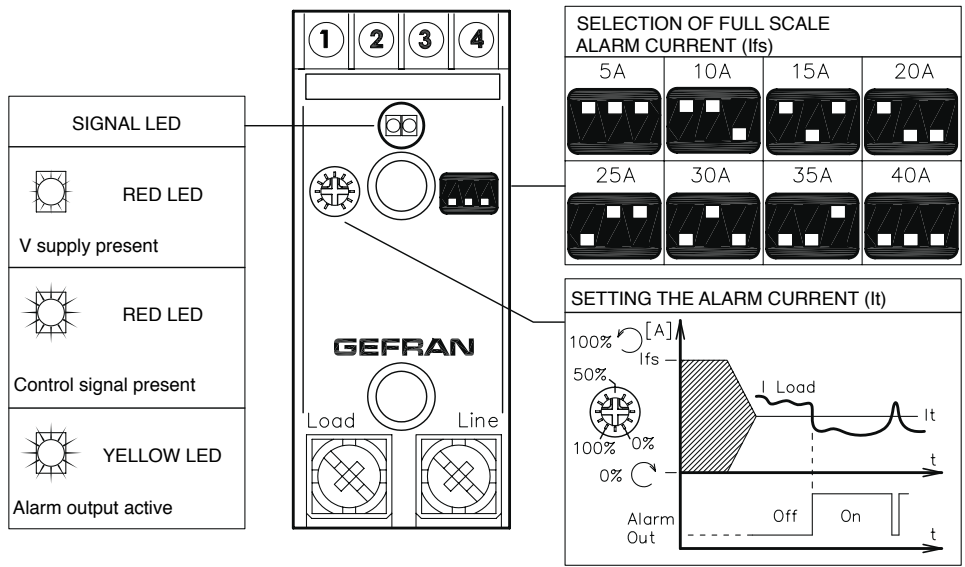

**Example:**

Vn=230V Rated voltage of load

Il= 26.5 A Load current

It\*= 21 A Alarm setpoint: alarm trips if current drops below this value.

(\*) When setting the alarm current (It), remember that line fluctuations (normally ± 10%) vary the value of current Il by the same percentage. Therefore, you have to set the setpoint with the necessary margins to prevent false alarm signals.

With the dip switches, set the full scale value of the alarm current (Ifs) according to the following table:

Load current (Il) @ Vn	0%	50%	Full scale alarm current (Ifs)
0...4A	1.08	4.2	5A
4...9A	1.37	6.4	10A
9...13A	1.47	8.4	15A
13...18A	1.57	10.6	20A
18...22A	1.64	12.6	25A
31...40A	1.82	19	40A

Therefore, with con Il = 26.5 A, set the full scale current at Ifs = 30A



With the trimmer, set the alarm current (It) according to the following formula:

$$TR\% = It / Ifs * 100$$

In the example TR% = 21[A] / 30[A] \* 100 = 70%

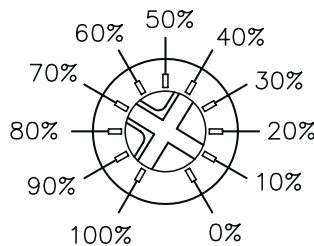

**Checking the Hb alarm**

Activate the device by feeding the load to maximum current.

With current-sensing pliers, check current to the load (Il).

The yellow alarm LED must be off.

Turn the trimmer counterclockwise: alarm current It increases.

When the yellow alarm LED lights up, the alarm current equals load current (It= Is).

The alarm is active.

Turn the trimmer clockwise to reduce alarm current It until the trimmer returns to its original position (with the yellow LED off).

## DIMENSIONS AND CUT-OUT

## TEMPLATE DIMENSIONS

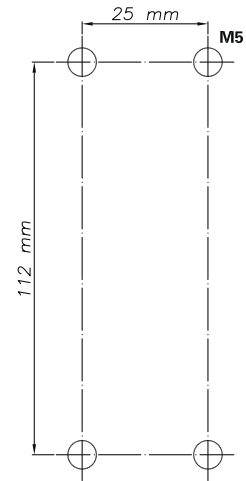
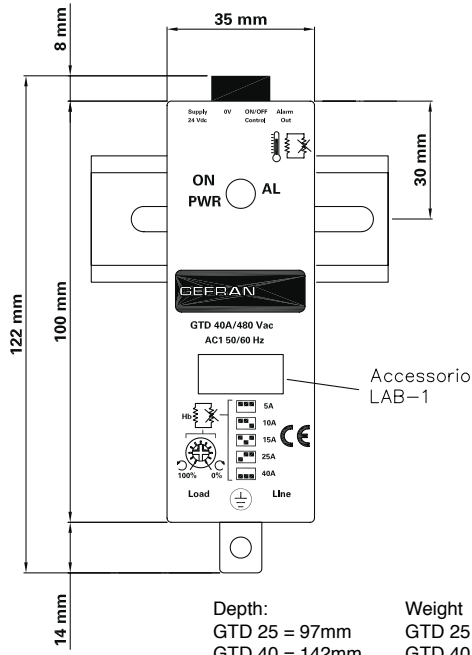

## DISSIPATION CURVES

Rated current curves based on room temperature

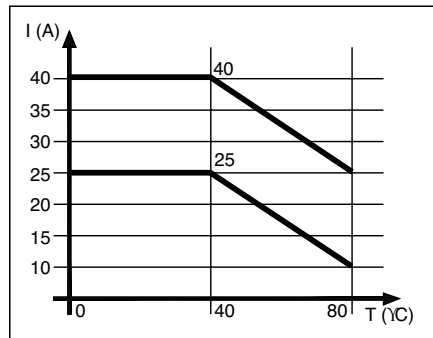

## CONNECTION EXAMPLES

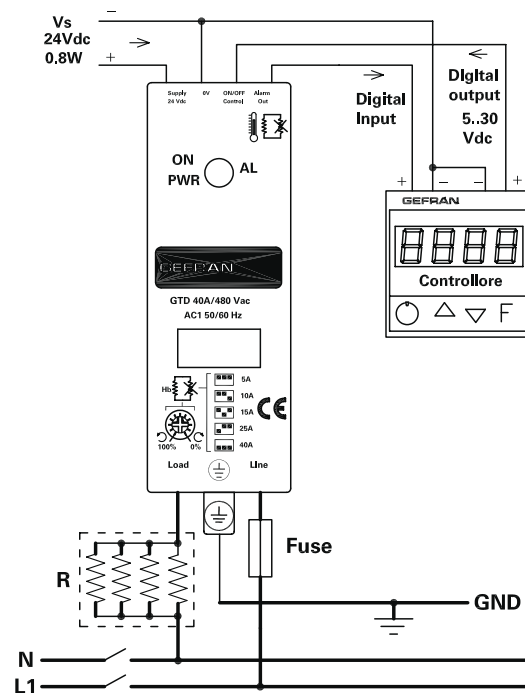

**TABLE FOR TERMINAL CHOICE OF POWER TERMINAL BOARD**

Size	Control terminal (1, 2, 3, 4)			Power terminal (LINE, LOAD)		
	Contact area (WxD) screw type	Pre-isolated wire terminal	Wire section * / tightening torque	Contact area (WxD) screw type	Pre-isolated wire terminal	Wire section * / tightening torque
25A 40A	6,3x9 M3	Eye / fork / tip	min. 0.35 mm <sup>2</sup> max. 2,5 mm <sup>2</sup>  0,6 Nm Max	11,5x12 M5	Eye / fork / tip	min. 1 mm <sup>2</sup> max. 10 mm <sup>2</sup> (tip)  min. 1 mm <sup>2</sup> max. 16 mm <sup>2</sup> (Eye/fork)  1,5 - 2,2 Nm

(\*) The maximum sections indicated refer to unipolar copper wires with PVC insulation.

Note: you have to use an eye terminal for the ground connection. (WxD) = width x depth [mm]

Described below is the minimum permissible rated section based on the rated currents of power solid state relays, for copper wires isolated in PVC in continuous operation and at 40°C room temperature, according to standards CEI 44-5, CEI 17-11, IEC 408 in compliance with EN60204-1.

Rated current	Rated wire section in mm <sup>2</sup>	AWG
10A	2.5	13
25A	6	9
40A	10	7

**ACCESSORIES**

A wide range of accessories is available (including fuses and fuse holders, heatsinks, ID plates). To choose accessories, see the section "Solid state relays - Accessories".

**ORDER CODE**

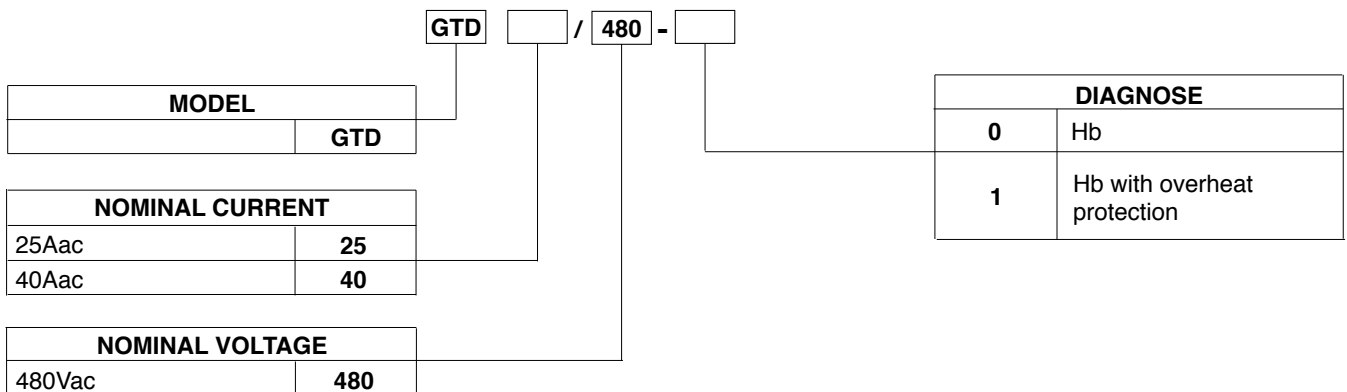

Please contact GEFTRAN personnel for information on availability of codes.

## •WARNINGS



WARNINGS: this symbol indicates danger.

### **Before installation, please read the following advices:**

- follow the indications of the manual scrupulously when making the connections to the instrument.
- use a cable that is suitable for the ratings of voltage and current indicated in the technical specifications.
- if the instrument is used in applications where there is risk of injury to persons and damage to machines or materials, it is essential that it is used with an auxiliary alarm device.
- Power controllers are designed to assure a switching function that does not include protection of the load line or of devices connected to it. The customer must provide all necessary safety and protection devices in conformity to current electrical standards and regulations. It is advisable to verify frequently that the alarm device is functional even during the normal operation of the equipment.
- the instrument must NOT be used in environments where there could be the presence of dangerous atmospheres (flammable or explosive).
- during continuous operation, the heatsink may reach 100°C and remain at a high temperature due to thermal inertia even after the device is switched off. Therefore, do not touch the heat sink or the electrical wires.
- do not operate on the power circuit unless the main supply is disconnected.
- do not open the cover if device is "ON"!
- we recommend installing a cooling fan inside the electrical cabinet near the GTD devices!

### **Installation:**

- connect the device to the ground using the proper ground terminal.
- the power supply wiring must be kept separate from that of inputs and outputs of the instrument; always check that the supply voltage corresponds to that indicated on the instrument cover.
- avoid dust, humidity, corrosive gases and heat sources;
- keep away from dust, humidity, corrosive gases and heat sources.
- respect the installation distances between one device and another (to allow for dissipation of generated heat).
- we recommend installing a cooling fan inside the electrical cabinet near the GTD devices;

### **Maintenance:**

- Periodically check the operation of any cooling fans and clean the cabinet air filters at regular intervals.
- Repairs must be performed only by specialized or appropriately trained personnel. Cut off power to the device before accessing internal parts.
- Do not clean the box with solvents derived from hydrocarbons (trichloroethylene, gasoline, etc.). Using such solvents will compromise the mechanical reliability of the device. To clean external plastic parts, use a clean cloth wet with ethyl alcohol or water.

### **Technical service:**

GEFRAN has a technical service department.

Defects caused by use not conforming to the instructions are excluded from the warranty.



This device conforms to European Union Directive 2014/30/EU and 2014/35/EU as amended with reference to generic standards: **EN 61000-6-2** (immunity in industrial environment) **EN 61000-6-4** (emission in industrial environment) - **EN 61010-1** (safety regulations).

DTS\_GTD\_09-2018\_ENG

## **SOUTHWEST HEATER AND CONTROLS**

**10610 Control Place, Dallas Texas 75238**

Main# 214-340-7500

Toll Free#: 800-687-2220

EMAIL: sales@swhc.com

WEB: www.swhc.com