

Main applications

- Industrial furnaces for heat treatments, metallurgy
- Fusion, sinterization, nitration furnaces
- Furnaces for ceramics and precious metals
- Dryers
- Heating systems with infrared lamps (long-, medium-, short-wave)
- Wood edge banding Machines
- Plastic-blowing Machines
- Welding applications on Packaging Machinery
- Thermoforming Machines
- Furnaces with Super Kanthal™ Silicon carbide heating elements



Main features

- Current levels from 40A to 250A
- Rated voltage 480Vac, 600Vac and 690Vac
- Trigger configurable in "Zero crossing" (Fixed Cycle, Burst Firing, Half single Cycle) or "Phase angle"
- Analog control input, configurable in: Volt, mA, potentiometer (digital in PWM)
- Total and partial load interrupt alarm (HB) (optional)
- Communication Modbus RTU, RS 485 2 wires (optional)
- Current limit (optional)
- V, I, P feedback (optional)
- Connections for monophase and triphase applications (just in zero crossing" mode)
- Configuration from PC (by USB – TTL cable)
- CE, TÜV, UL Marking

PROFILE

The "GTF" series of microprocessor advanced solid state power unit controls, in compact and optimized solutions, offer various power outputs for use with different types of heating elements. Current levels range from 25A to 250A, nominal voltage from 480Vac, 600Vac and 690Vac. The command input is configurable and accepts 0-10V, 0/4-20mA signals, potentiometers, logic signals, including with PWM modes for cost effective solutions. The device can also be operated via Modbus RTU serial communication, with cascade chain connections facilitated by plug-in RJ10 (telephone) connectors. The many trigger modes are software configurable and provide:

- ZC:

Zero Crossing constant cycle time (settable in range 1-200sec), for conventional loads

-BF: Burst-Firing, Zero crossing with optimized minimum cycle time, for systems with low thermal inertia, medium-wave IR lamps

- HSC:

Half Single Cycle Zero Crossing (corresponding to Burst Firing) that manages single semi-cycles of conduction or stop cycles, useful for short-wave IR lamps, reduces flickering and limits generation of EMC noise on the power line (applied only to single-phase load or 3-phase open delta 6 leads)

- PA:

Phase angle control, useful for short-wave IR lamps, transformer primaries. Completely eliminates flickering of load filaments. Soft Start and soft stop ramp functions can be assigned to these controls with limitation of current peaks and/or maximum RMS current level.

Thanks to sophisticated Hardware and Software solutions, you can precisely control different types of loads.

Phase angle control matched with **current limit** and **current, voltage, or load power feedback** functions, can be used with "critical" applications such as (for example), special resistors such as special Super Kanthal™ heating elements, Silicon Carbide resistors, or transformer primaries.

GTF runs complete diagnostics of current, voltage, power, and temperature levels:

Current Diagnostics:

- Total and partial load interrupt alarm
- Self-learn function of alarm limit for interrupted load
- Alarm for SCR in short circuit
- Alarm for load in short circuit or overcurrent
- Alarm for interrupted internal fuse

Voltage Diagnostics:

- Alarm for absence of phase

Temperature Diagnostics:

- Alarm for over temperature of power module

The power control with Soft start ramp limits load current peaks at power-on, optimizes the consumptions and increases the load operating duration.

A specific, linear Soft Start curve, designed to control gradually the current in the initial phase is available for IR lamps.

Device parameters can be configured from PC, by means of a simple configuration SW which lets you save all parameters in a configuration file that is easy to manage and to copy to other devices.

Moreover, an RS485 serial connection of

GTF is offered with Modbus RTU protocol to control currents, voltages, powers, load status, and device status from the supervisor terminal (HMI) or PLC.

Installation notes:

- To ensure maximum reliability, it is essential to install the unit correctly in the panel in order to guarantee adequate heat exchange between the heat sink and the room under natural convection conditions.
- Install the unit vertically (max 10° inclination from vertical axis).
- Vertical distance between unit and panel wall >100mm
- Use the high speed fuses specified in the catalog
- Applications with solid state power units must also include an automatic safety switch to cut out the load power line.

Short circuit protection

Products listed in table "UL508 SCCR FUSES TABLE" are suitable for use on a circuit capable of delivering not more than 100,000 A rms Symmetrical Amperes, 600 Volts maximum when protected by fuses. Use fuses only

According to UL508, test at 100.000A were carried out with class J fuses rated xxxA (refer to table "SCCR fuse protection table" to details of the current size fuses for the fuse).

For products complying with the UL508 standard, the use of fuses in the "UL508 SCCR FUSES TABLE" table does not guarantee the operation of the device following a short circuit.

To guarantee the functioning of the device

after the short circuit, it is recommend the use of extra rapid fuses as in table "EXTRARAPID FUSES".

For products GTF up to 120A, the use of fuses in the "SCCR CO-ORDINATION FUSES TABLE" guarantee the operation of the device following a short circuit.

ATTENTION: The opening of the branch-circuit protective device may be an indication that a fault has been interrupted. To reduce the risk of fire or electric shock, current-carrying parts and other components of the device should be examined and replaced if damaged. If burnout of the device occurs, the complete device must be replaced or equivalent.

DESCRIPTION OF CONNECTIONS GTF 25-120A

Top view
WITH OUT option Fieldbus

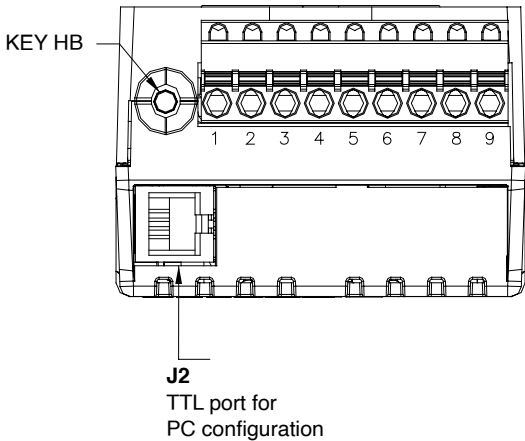

Top view
WITH option Fieldbus

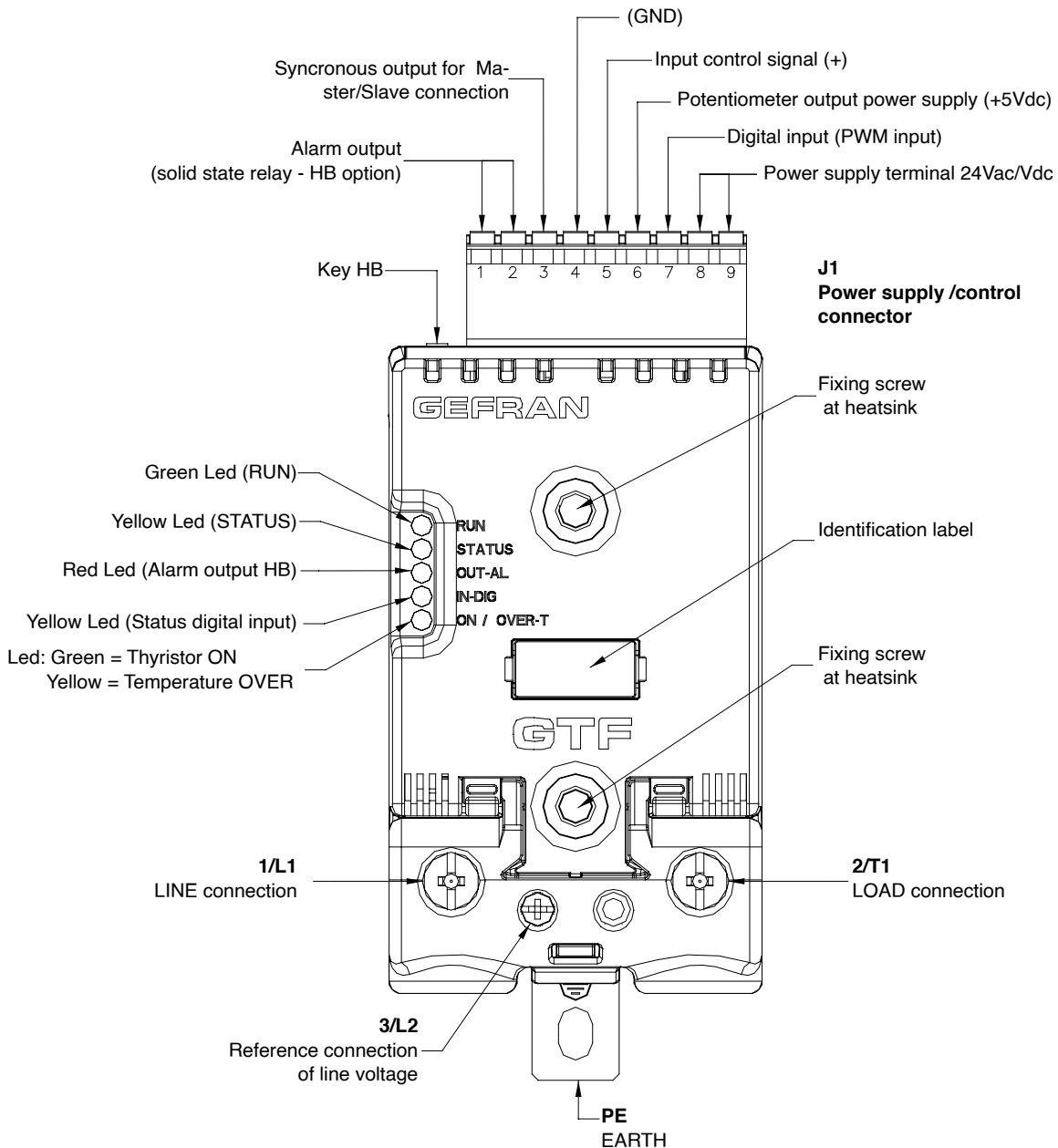
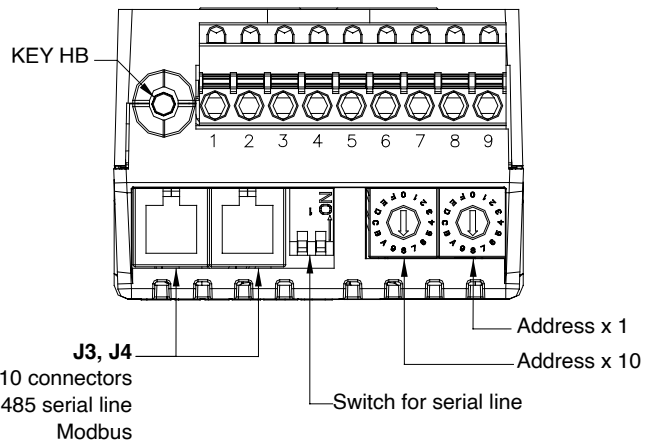

GTF 150-250A DESCRIPTION OF CONNECTIONS

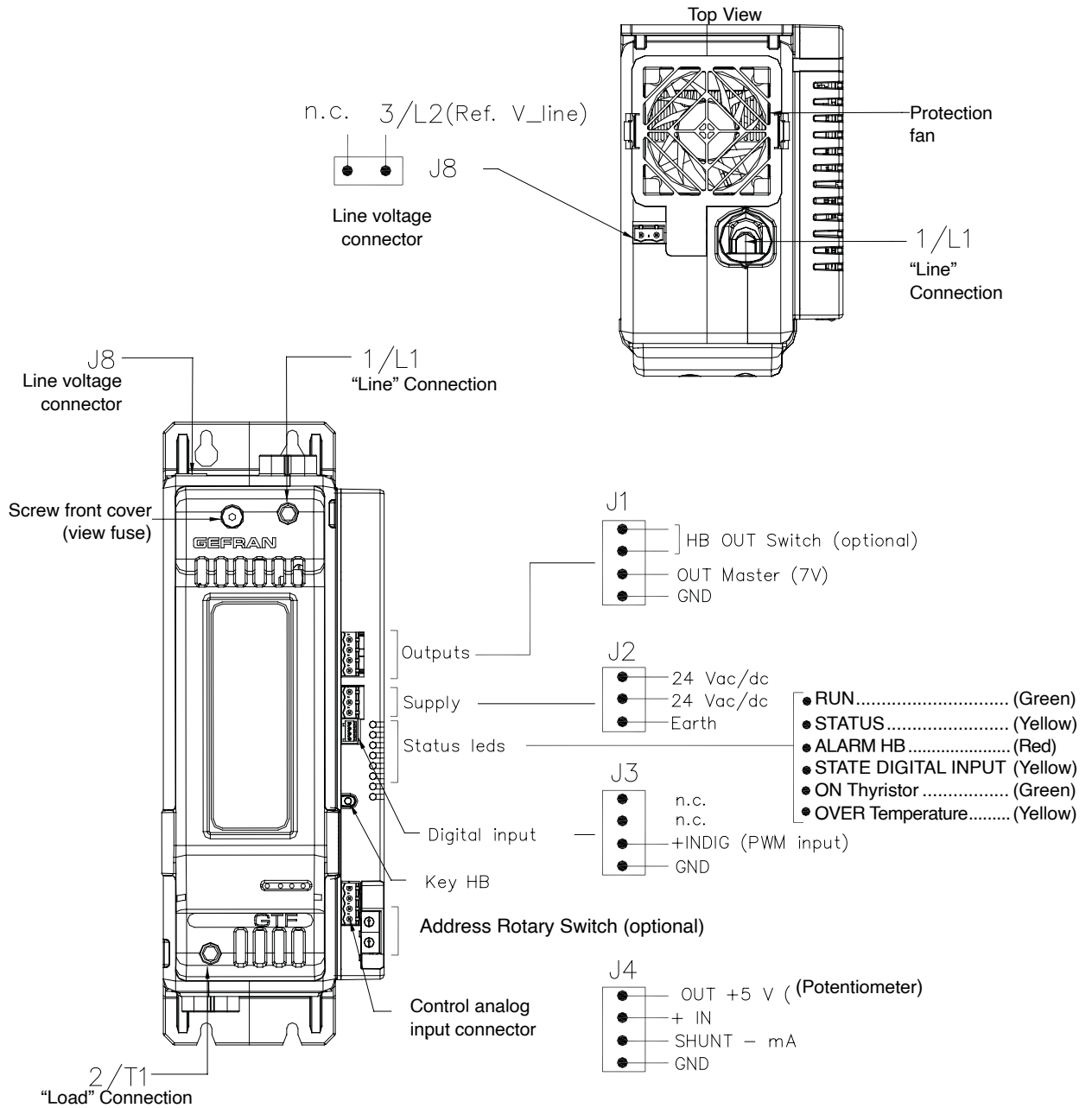

Low view WITHOUT option RS485 serial line

Low view WITH option RS485 serial line

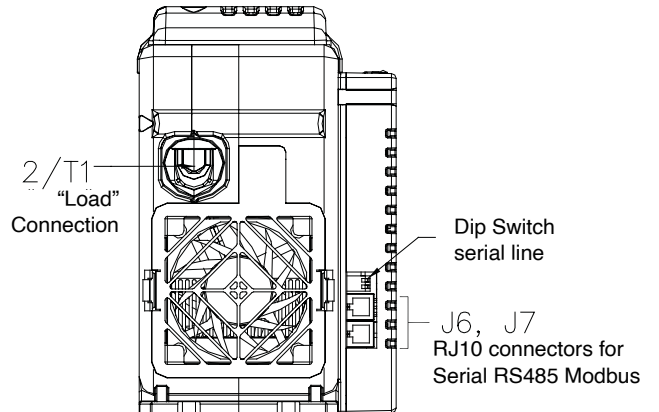
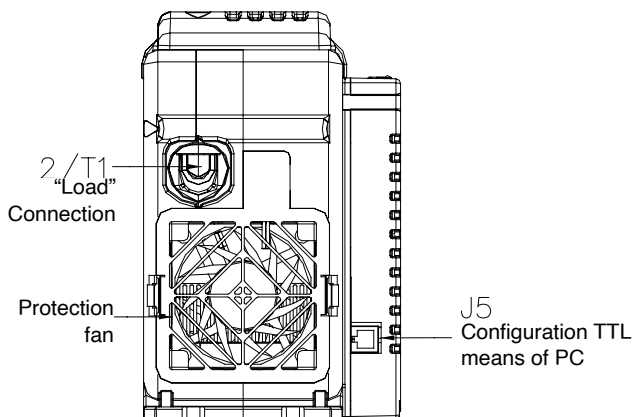

DERATING CURVES GTF

GTF 25 / 40

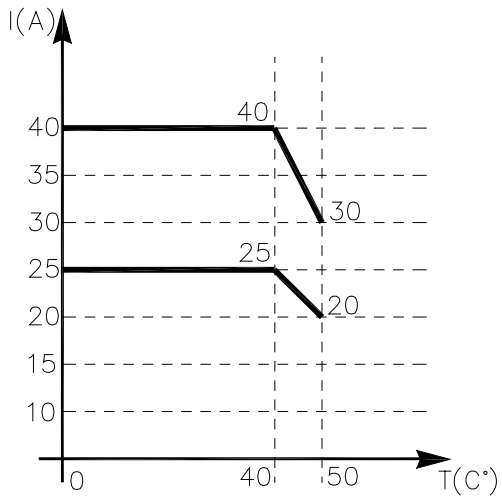

GTF 50 / 60

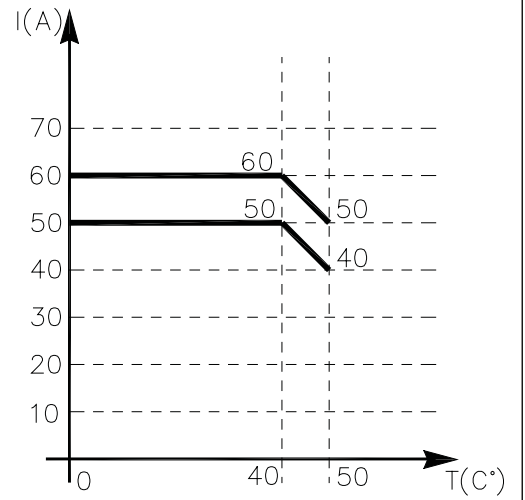

GTF 75 / 90 / 120

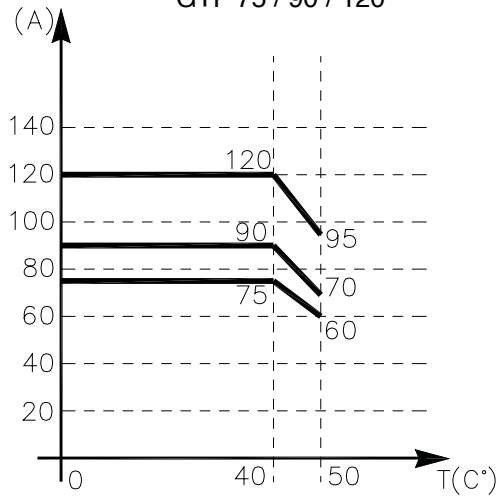

GTF 150 / 200 / 250

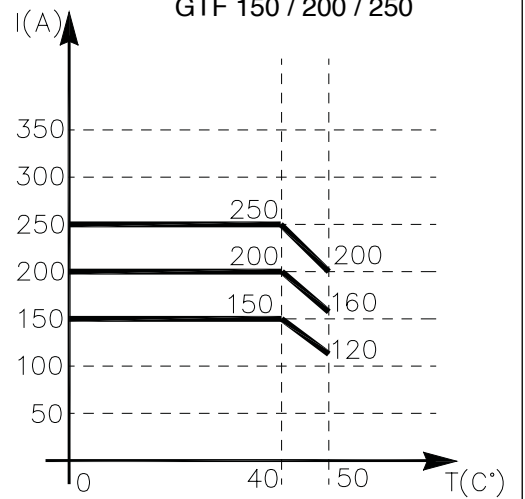

FUNCTION MODE

Trigger modes

The GTF provides the following power control modes:

- modulation via variation of phase angle: PA modality
- modulation via variation of number of conduction cycles with "zero crossing" trigger": ZC, BF, HSC modality.

PA - Phase angle

This mode manages power on the load by modulating load phase angle (only mono-phase)

ex: if power to be transferred to the load is 100%, $\theta = 180^\circ$

ex: if power to be transferred to the load is 50%, $\theta = 90^\circ$

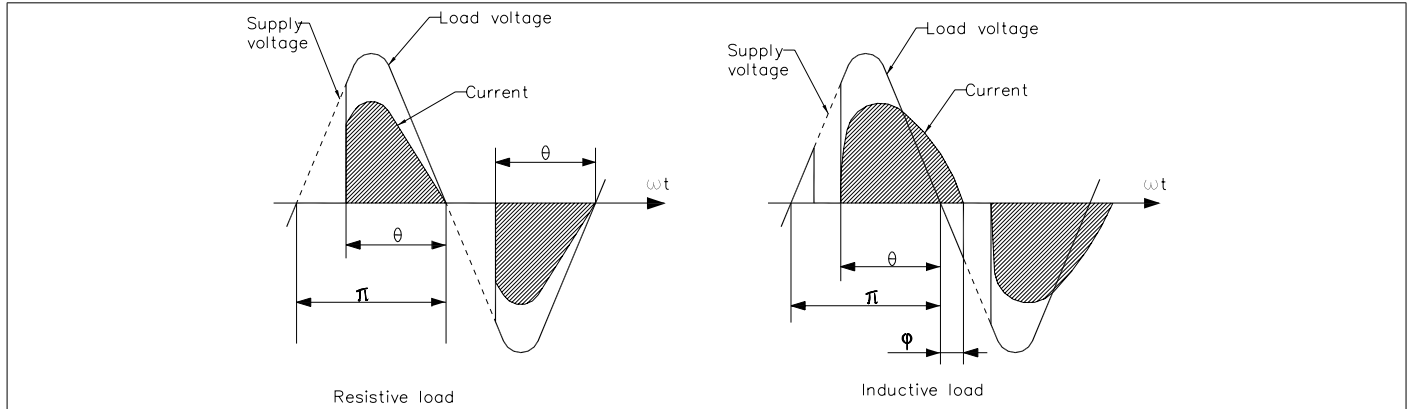

Zero Crossing mode

This function eliminates EMC noise. This mode controls power on the load via a series of conduction ON and non conduction OFF cycles.

ZC - Zero Crossing constant cycle time ($T_c \geq 1$ sec, settable from 1 to 200 sec) Cycle time is divided into a series of conduction and non conduction cycles in proportion to the power value to be transferred to the load. (mono-phase or bi-phase).

For example, if $T_c = 10$ sec, if the power value is 20% there is conduction for 2 sec (100 conduction cycles @ 50Hz) and non conduction for 8 sec (400 non conduction cycles @ 50Hz).

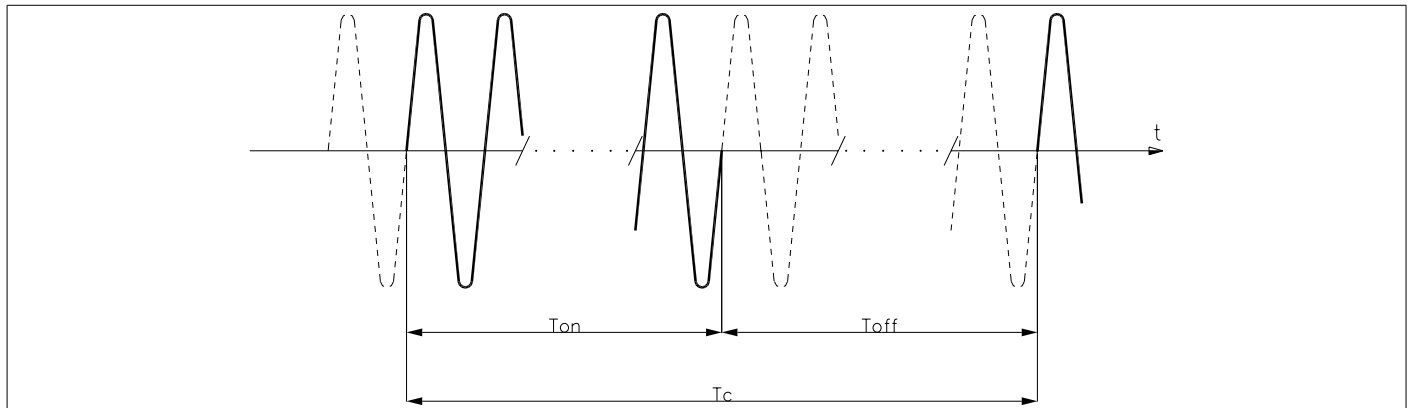

BF - Burst Firing, Zero Crossing variable cycle time (mono-phase or bi-phase).

This mode controls power on the load via a series of conduction ON and non conduction OFF cycles. The ratio of the number of ON cycles to OFF cycles is proportional to the power value to be supplied to the load.

The CT repeat period is kept to a minimum for each power value (whereas in ZC mode the period is always fixed and not optimized).

A parameter defines the minimum number of conduction cycles settable (from 1 to 10). In the example, this parameter = 2

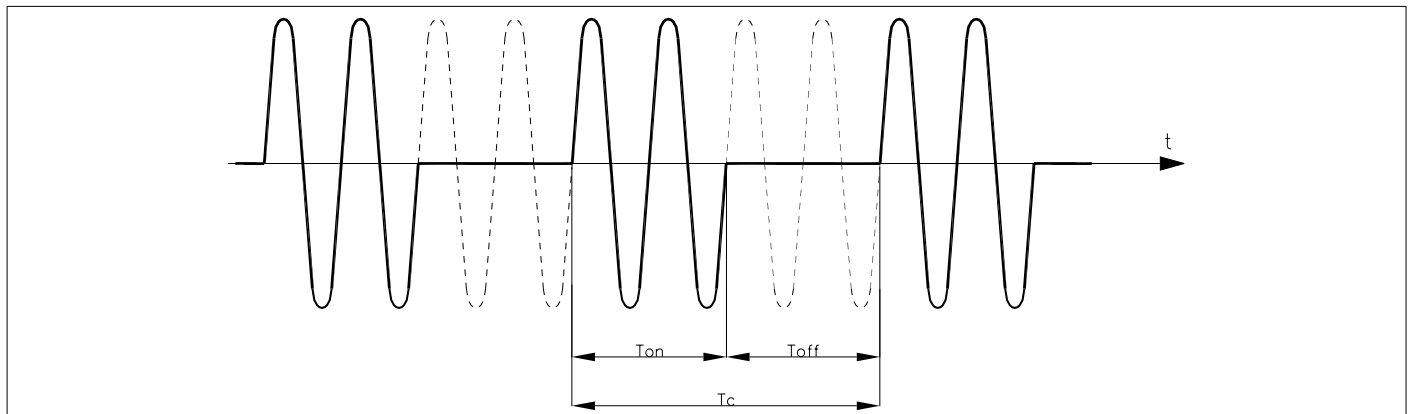

Example of operation in BF mode with power at 50%

HSC - Half single cycle

This mode corresponds to Burst Firing that manages ON and OFF half-cycles.

It is useful for reducing the flickering of filaments with short/medium-wave IR lamp loads. With these loads, to limit operating current with low power, it is useful to set a minimum power limit (for example, $Lo.p = 10\%$).



NB: This mode is NOT allowed with inductive loads (transformers). It is used with resistive loads in single-phase, star with neutral, or open delta configuration.

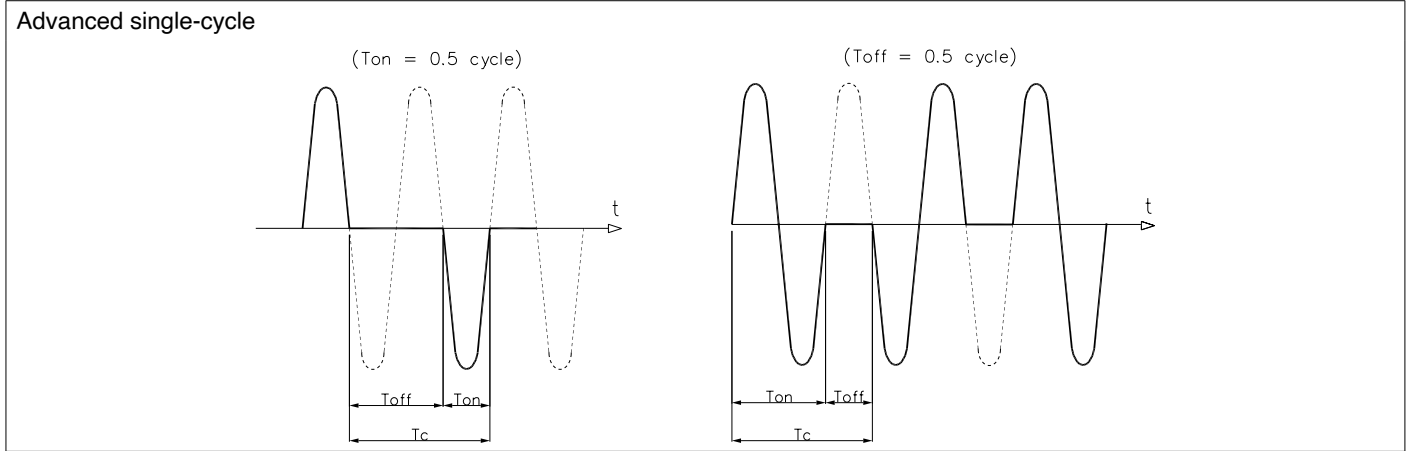

Example of operation in HSC mode with power at 33 and 66%

Softstart or Ramp at power-on

This type of start can be enabled in either phase control or pulse train mode, mon-phase.

With phase control, the increment of firing angle stops at the corresponding power value to be transferred to the load.

The control of maximum current spike can be enabled during the ramp phase (this is useful in case of short circuit on the load or loads with other temperature coefficients to automatically adjust the start time of the load).

The ramp is automatically re-enabled if the GTF remains off for a (settable) time.

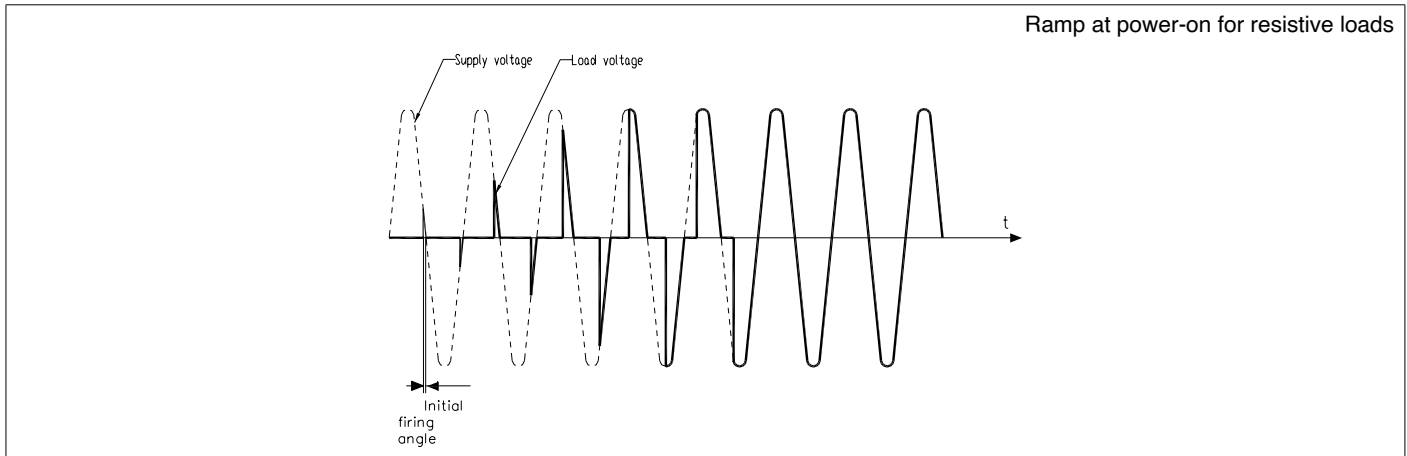

DT - "Delay triggering" of first cycle (only for control modes ZC, BF mon-phase)

Settable from 0° to 90° .

Useful for inductive loads (transformer primaries) to prevent current spike that could in certain cases trip the high-speed fuses that protect the SCRs.

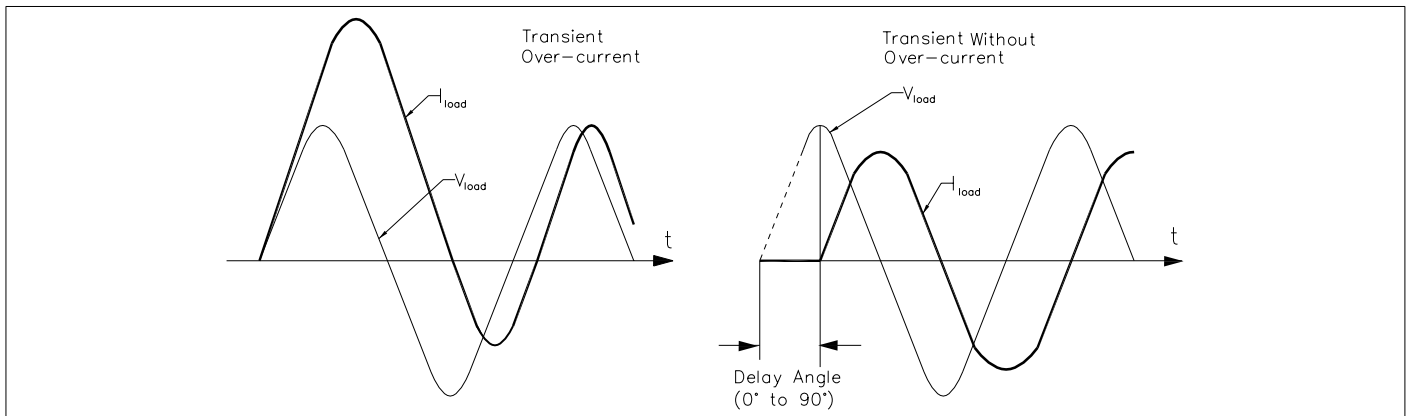

DIMENSIONS

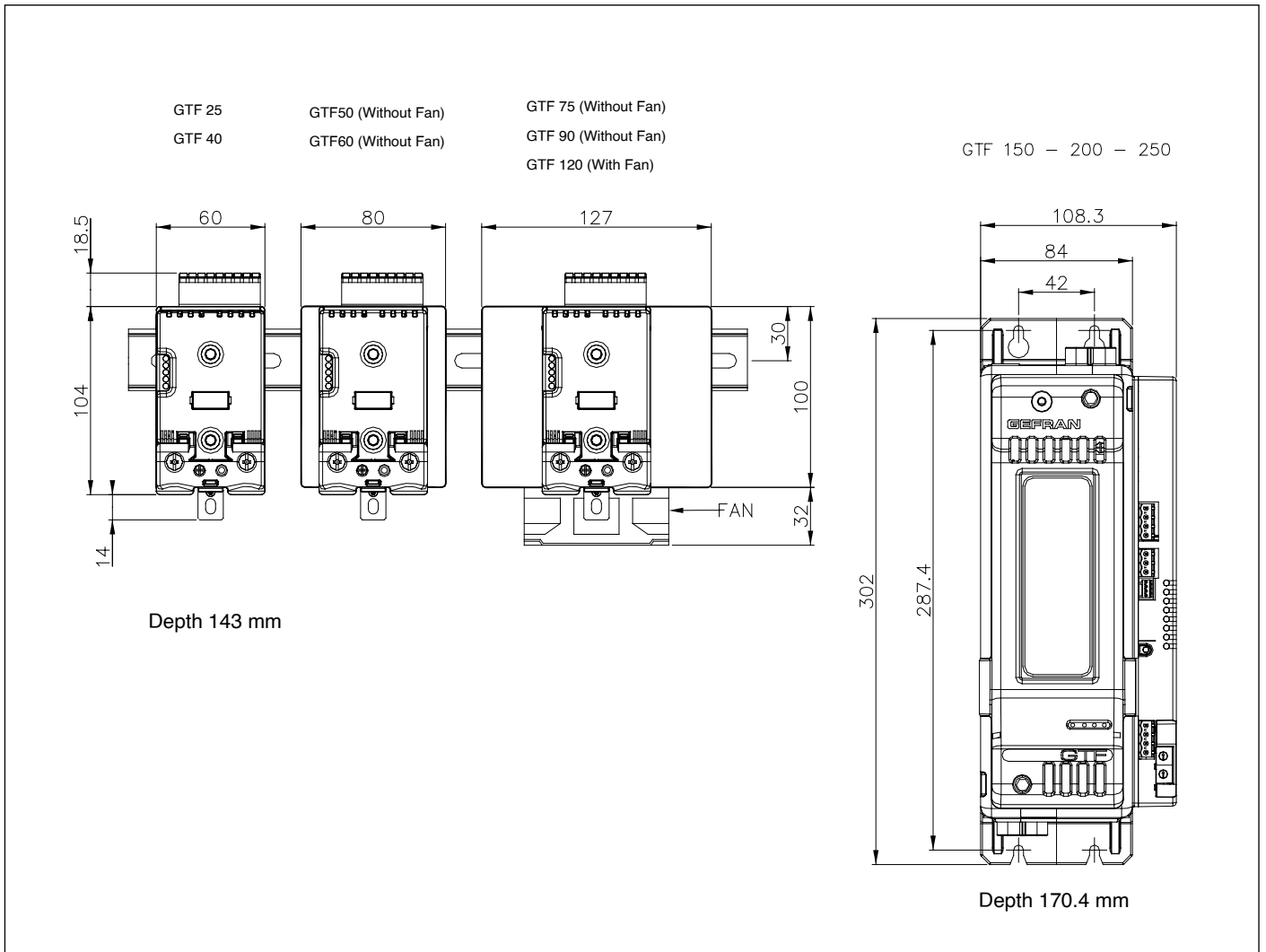

TEMPLATE DIMENSIONS

	L (mm)	W(mm)
Models		
GTF 25-40-50-60A:	112	44
GTF 75-90-120A:	112	113
GTF 150-200-250A	287	42

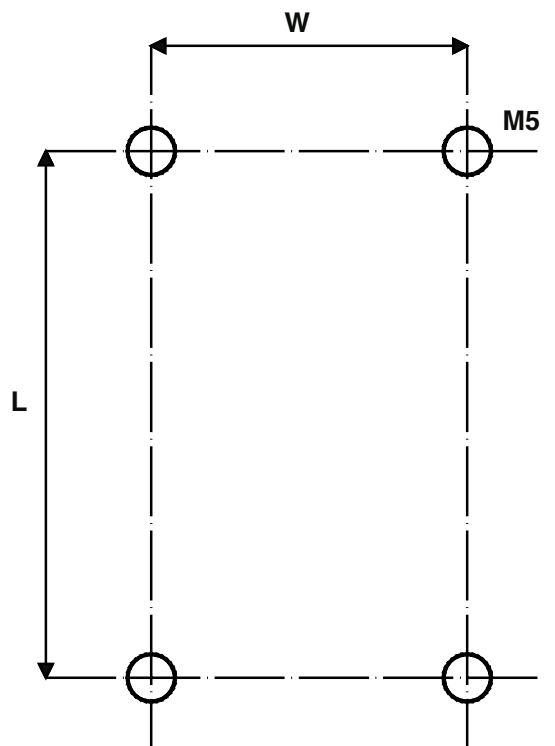

TECHNICAL DATA

General features

Category of use: AC51, AC55b, AC56a

Load type:

AC51 resistive or low-inductance loads

AC55b infrared lamp

AC56a transformers, resistive loads with high temperature coefficient

Switch-on modes:

ZC Zero crossing constant cycle time (1-200sec)

BF Burst Firing variable cycle time (GTT) minimum or optimized

HSC Half Single Cycle corresponds to Burst Firing that manages Semi-cycles of on and off. Useful to reduce flickering with short-wave infrared loads

PA Phase Angle

Nominal voltage:

480Vac (max range 90-530Vac)

600Vac (max range 90-660Vac)

690Vac (max range 90-760Vac)

Nominal frequency: 50-60Hz

Non-repetitive voltage:

1200Vpk (models 480Vac)

1600Vpk (models 600Vac/690Vac)

Control analog input

Voltage: 0...5Vdc, 0...10Vdc

(impedance >100KΩ)

Current: 0...20mA, 4...20mA

(impedance 125Ω)

Potentiometer: from 1kΩ to 10k Ω

(auto-fed by 5V by GTF)

Digital inputs

Range 5-30V max 7mA

PWM input control: max 100Hz

(Configurable Features).

Voltage line range:

Range: 90... V_nominal_product

Frequency: 50-60Hz

Accuracy: 2% f.s

Current load range:

Range: 0... 2* I_nominal_product

Accuracy: 3% f.s

Sampling 0,2 msec

HB alarm output (optional)

The HB function detects partial or total load interruption.

The control measures load current by means of an internal device.

The current limit value is set via an automatic procedure activated with the HB button located near the upper connector.

The alarm output is obtained by means of a solid relay, with normally open contact (max 30V, 150mA, maximum conduction resistance 15Ω).

Modbus RS485 serial (optional)

This option lets you connect the device to a PC, PLC, HMI with a simple RJ10 telephone wire, by using an RS485 serial line with Modbus protocol.

The Baud-Rate is configurable from 1200 Baud to 19200 Baud.

A pair of rotary-switches lets you quickly assign the node address.

A dip-switch near the rotary-switches lets you internally insert the line termination resistance. Isolation 300V

OUTPUTS

IsolationHV

Rated isolation voltage input/output: 4000Vac

GTF 25

Nominal current 25 Arms @ 40°C

in continuous service.

Non-repetitive overcurrent t=10ms: 400 A

I²t for blowout: 450 A²s

dV/dt critical: 1000 V/μs

GTF 40

SCCR: 100KA 600V with co-ordination fuse

Nominal current 40 Arms @ 40°C in continuous service.

Non-repetitive overcurrent t=10ms: 520 A

I²t for blowout: 1800 A²s

dV/dt critical: 1000V/μs

GTF 50

SCCR: 100KA 600V with co-ordination fuse

Nominal current 50 Arms @ 40°C

in continuous service.

Non-repetitive overcurrent t=10ms: 520 A

I²t for blowout: 1800 A²s

dV/dt critica: 1000V/μs

GTF 60

SCCR: 100KA 600V with co-ordination fuse

Nominal current 60Arms @ 40°C

in continuous service.

Non-repetitive overcurrent t=10ms: 1150A

I²t for blowout: 6600 A²s

dV/dt critical: 1000V/μs

GTF 75

SCCR: 100KA 600V with co-ordination fuse

Nominal current 75Arms @ 40°C

in continuous service.

Non-repetitive overcurrent t=10ms: 1150A

I²t for blowout: 6600 A²s

dV/dt critical: 1000V/μs

GTF 90

SCCR: 100KA 600V with co-ordination fuse

Nominal current 90Arms @ 40°C

in continuous service.

Non-repetitive overcurrent t=10ms: 1500A

I²t for blowout: 11200 A²s

dV/dt critical: 1000V/μs

GTF 120

SCCR: 100KA 600V with co-ordination fuse

Nominal current 120Arms @ 40°C in continuous service.

Non-repetitive overcurrent t=10ms: 1500A

I²t for blowout: 11200 A²s

dV/dt critical: 1000V/μs

GTF 150

SCCR: 100KA 600V with co-ordination fuse

Nominal current 150Arms @ 40°C

in continuous service.

Non-repetitive overcurrent t=10ms: 5000A

I²t for blowout: 125000 A²s

dV/dt critical: 1000V/μs

GTF 200

Nominal current 200 Arms @ 40°C

in continuous service.

Non-repetitive overcurrent t=10ms: 8000A

I²t for blowout: 320000 A²s

dV/dt critical: 1000V/μs

GTF 250

SCCR: 100KA 600V UL508 conformant

Nominal current 250Arms @ 40°C in continuous service.

Non-repetitive overcurrent t=10ms: 8000A

I²t for blowout: 320000 A²s

dV/dt critical: 1000V/μs

Thermic Dissipation:

SCCR: 100KA 600V UL508 conformant

GTF models dissipate thermic power

based on load current:

Pdissipation = I_load_Arms * 1.3V (W)

For 150, 200, 250 A models with

integrated fuse, also consider dissipated power at rated current shown on the fuse table.

LED

N.5 LEDs indicator:

RUN (green)

STATUS (yellow)

ALARM (red)

DIGITAL INPUT (yellow)

ON / OVER-TEMP. (green / yellow)

Power supply (model GTF 25-120A)

24Vdc/Vac +/-25%

Input @ 25Vdc: max 100mA

Power: max 3VA

Maximum voltage insulation from control signals: 300 V

Power supply (model GTF 150-250A)

24Vdc/Vac +/-25%

Input @ 25Vdc: max 450mA

Power: max 11VA

Maximum voltage insulation from control signals: 300 V

Fan Power supply
(only for model GTF 120A):

24Vdc/+-10%

Input @ 25Vdc: max 200mA

Ambient conditions:

Working temperature: 0-50°C (see the de-rating curve)

Storage temperature: -20°C - +70°C

Max. relative humidity: 85% not condensing

Max. installation altitude: 2000m slm

Pollution level: 2

Installation

For models 25-120A bar DIN EN50022

For models 150-250A panel

Dimensions:

see dimensions and installation

Weight

GTF 25/40	0,81 Kg
GTF 50/60	0,97 Kg
GTF 75/90	1,3 Kg
GTF 120	1,5 Kg
GTF150/200/250 with integrated fuse	2,6 Kg

ELECTRICAL CONNECTION

POWER CONNECTION

SECTION CABLES RECOMMENDED

GTF CURRENT LEVEL	TERMINAL	CABLE WIRE	WIRE TERMINAL	TIGHTENING TORQUE / TOOL
25A	1/L1, 2/T1, PE	4 mm ² 10 AWG	Wire terminal / Eye D. 6mm	2.5 Nm / Phillips screwdriver PH2 - PH3
40A	1/L1, 2/T1, PE	10 mm ² 7 AWG	Wire terminal / Eye D. 6mm	2.5 Nm / Phillips screwdriver PH2 - PH3
50A	1/L1, 2/T1, PE	10 mm ² 7 AWG	Wire terminal / Eye D. 6mm	2.5 Nm / Phillips screwdriver PH2 - PH3
60A	1/L1, 2/T1, PE	16 mm ² 5 AWG	Wire terminal / Eye D. 6mm	2.5 Nm / Phillips screwdriver PH2 - PH3
75A	1/L1, 2/T1, PE	25 mm ² 3 AWG	Wire terminal / Eye D. 6mm	2.5 Nm / Phillips screwdriver PH2 - PH3
90A	1/L1, 2/T1, PE	35 mm ² 2 AWG	Wire terminal / Eye D. 6mm	2.5 Nm / Phillips screwdriver PH2 - PH3
120A	1/L1, 2/T1, PE	50 mm ² 1/0 AWG	Wire terminal / Eye D. 6mm	2.5 Nm / Phillips screwdriver PH2 - PH3
-	3/L2 (Ref. Vline)	0.25 ...2.5 mm ² 23...14 AWG	wire terminal tip	0.5 ...0.6 Nm / Screwdriver blade 0.6 x 3.5 mm
150A	1/L1, 2/T1	70 mm ² 2/0 AWG	Wire stripped for 25 mm or with crimped pre-insulated terminal tube CEMBRE PKC70022	6 Nm / No. 6 hex head wrench
200A	1/L1, 2/T1	95 mm ² 4/0 AWG	Wire stripped for 25 mm or with crimped pre-insulated terminal tube CEMBRE PKC95025	6 Nm / No. 6 hex head wrench
250A	1/L1, 2/T1	120 mm ² 250 AWG	Wire stripped for 25 mm	6 Nm / No. 6 hex head wrench
-	3/L2 (Ref. Vline)	0.25 ...2.5 mm ² 23...14 AWG	Wire stripped for 8 mm or with tag terminal	0.5 ...0.6 Nm / Flat-head screwdriver tip 0,6 x 3.5 mm

Note: Cables must be copper "Stranded Wire" or "Compact-Stranded Wire" type with maximum operating temperature 60/75°C

SIGNAL CABLE

GTF 25-120: J1 GTF 150-250: J1, J2, J4 GTF 150-250: J5, J7		0,2 - 2,5mm ²	24 - 14AWG
		0,25 - 2,5mm ²	23 - 14AWG
GTF 150-250: J3		0,14 - 0,5mm ²	28 - 20AWG
		0,25 - 0,5mm ²	23 - 20AWG

	Connector RJ10 4-4 pin	Nr. Pin	Name	Description	Note
RS 485		1	GND1 (**)		(**) Insert the line termination in the last device on the Modbus line.
		2	Tx/Rx+	Data reception/transmission (A+)	
		3	Tx/Rx-	Data reception/transmission (B-)	(**) Connect the GND signal among Modbus devices with a line distance > 100 m.
		4	+V (riservato)		
Cable type: flat telephone cable for pin 4-4 conductor 28AWG					

ORDERING CODE

GTF -

NOMINAL CURRENT	
25A	25
40A	40
50A	50
60A	60
75A	75
90A	90
120A	120
150A	150
200A	200
250A	250

NOMINAL VOLTAGE	
480V	480
600V	600
690V (**)	690

FIELDBUS	
0	Absent
M	MODBUS RTU

FUSIBLE	
0	Absent
1	Self-contained (for current sizes ≥150A)

DIAGNOSTICS ALARMS OPTIONS	
0	Absent
1	Alarm breach partial or total of load (HB)

CONTROL OPTIONS	
0	Absent
1	Current limit
2	Current limit and feedback V, I, P

(**) (Only for model with current ≥150A)

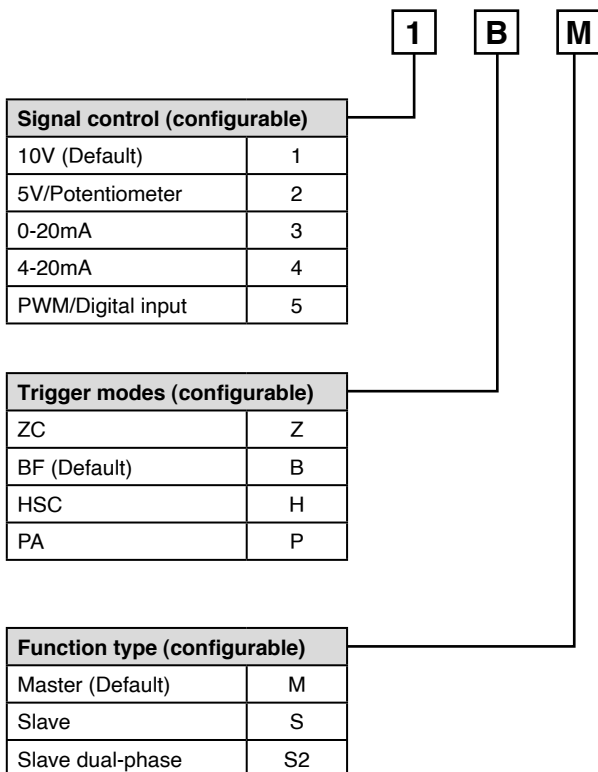

Note:

Configurator Standard 1-B-M, if not differently specified.

Substitution model:

GTS **GTF - X - 480 - 0 - 0 - 0 - 0 - 5 - Z - S**

GTT without load interrupted option

GTF - X - 480 - 0 - 0 - 0 - 0 - 1 - B - M

GTT with load interrupted option

GTF - X - 480 - 0 - 1 - 0 - 0 - 1 - B - M

GEFRAN spa reserves the right to make aesthetic or functional changes at any time and without notice

ACCESSOIRES

CONFIGURATION KIT

KIT PC USB / RS485 o TTL



kit for PC via the USB port (Windows environment) for GTF standard configuration (TTL port) for configuration of GTF with the RS485 option

Lets you read or write all of the parameters of a single GTF

A single software for all models

- Easy and rapid configuration
- Saving and management of parameter recipes
- On-line trend and saving of historical data

Component Kit:

- Connection cable PC USB <----> GTF port TTL
- Connection cable PC USB <----> GTF RS485 port
- Serial line converter
- CD SW GF Express installation

ORDERING CODE

GF_eXK-2-0-0.....Cod. F049095

FUSE / FUSEHOLDERS

Model	EXTRARAPID FUSES				FUSEHOLDERS
	Size I ² t	Sign Form	Model Code	Power dissipation @ In	Adoption Acronym Code
GTF 25	25A 390A ² s	FUS-025 10x38	FWC25A10F 338474	6W	PFI-10X38 337134 UR30A@690V
GTF 40... GTF 50...	50A 1600A ² s	FUS-050 22x58	FWP50A22F 338127	9W	PFI-22X58 337223 UR80A@600V
GTF 60...	63A 3080A ² s	FUS-063 22x58	FWP63A22F 338191	11W	PFI-22X58 337223 UR80A@600V
GTF 75...	80A 6600A ² s	FUS-080 22x58	FWP80A22F 338199	14W	PFI-22X58 337223 UR80A@600V
GTF 90...	125A 6950A ² s	FUS-125N	660RF00AT125 338106	25W	PF-DIN 337092 UR400A@1000V
GTF 120...	125A 6950A ² s	FUS-125N	660RF00AT125 338106	25W	PF-DIN 337092 UR400A@1000V
GTF 150...	200A 31500A ² s	FUS-200S	DN000UB69V200 338930	19W	
GTF 200/250 480V/600V	450A 196000A ² s	FUS-450S	DN00UB60V450L 338932	17W	
GTF 200/250 690V	400A 150000A ² s	FUS-400S	DN00UB69V400L 338936	20W	

SCCR CO-ORDINATION FUSES TABLE

Model	Short circuit current [Arms]	Max fuse size [A]	Bussmann Model Number	Max Voltage [VAC]
GTF 25	100.000	25	DFJ-25	600
GTF 40	100.000	50	DFJ-50	600
GTF 50	100.000	50	DFJ-50	600
GTF 60	100.000	100	DFJ-100	600
GTF 75	100.000	100	DFJ-100	600
GTF 90	100.000	100	DFJ-100	600
GTF 120	100.000	125	DFJ-125	600

The fuses on the above table are representative of all the Bussmann DFJ fuses with lower current ratings

The devices protected with the fuses reported above, still be functional after the short circuit

UL508 SCCR FUSES TABLE

GTF 200A 600V	Class J to up 400A
GTF 250A 600V	

ACCESSOIRES

A wide range of accessories is available (including fuses and fuse holders, supports for fastening DIN bar, ID plates, thermostats, current transformers and isolation transformers).
To choose accessories, see the section "Solid state relays - Accessories."

• WARNINGS



WARNING: this symbol indicates danger.

Before installation, please read the following advices:

- follow the indications of the manual scrupulously when making the connections to the product.
- use a cable that is suitable for the ratings of voltage and current indicated in the technical specifications.
- if the instrument is used in applications where there is risk of injury to persons and damage to machines or materials, it is essential that it is used with an auxiliary alarm device.

It is advisable to verify frequently that the alarm device is functional even during the normal operation of the equipment.

- The product must NOT be used in environments where there could be the presence of dangerous atmospheres (flammable or explosive).
- During continuous operation, the heatsink may reach 100°C and remain at a high temperature due to thermal inertia even after the device is switched off. Therefore, DO NOT touch the heat sink or the electrical wires.
- do not operate on the power circuit unless the main supply is disconnected.
- DO NOT open the cover if device is "ON"!

Installation:

- connect the device to the ground using the proper ground terminal.
- the power supply wiring must be kept separate from that of inputs and outputs of the instrument; always check that the supply voltage corresponds to that indicated on the instrument cover.
- Delete this line entirely.
- keep away from dust, humidity, corrosive gases and heat sources.

Maintenance: Check the correct operation of the cooling fans at regular intervals; clean the ventilation air filters of the installation at regular intervals.

- Repairs must be performed only by specialized or appropriately trained personnel. Cut off power to the device before accessing internal parts.
- Do not clean the box with solvents derived from hydrocarbons (trichloroethylene, gasoline, etc.). Using such solvents will compromise the mechanical reliability of the device. To clean external plastic parts, use a clean cloth wet with ethyl alcohol or water.

Technical service: GEFRAN has a technical service department. Defects caused by use not conforming to the instructions are excluded from the warranty.

GEFRAN spa reserves the right to make any kind of design or functional modification at any moment without prior notice

EAC	Conformity TC RU C-IT.A132.B.00422
CSA	Conformity C/CSA/US CoFC no. 70002856
CE	This device conforms to European Union Directive 2014/30/EU and 2014/35/EU with reference to standard: EN 60947-4-3 (product)
UL	Conformity C/UL/US File no. E243386 vol. 1 sez. 5
SCCR RMS SYM 100KA / 600V	Models: 200A, 250A - 480V and 600V, UL508 Conformant. Models up to 120A with co-ordination fuse

SOUTHWEST HEATER AND CONTROLS

10610 Control Place, Dallas Texas 75238

Main# 214-340-7500

Toll Free#: 800-687-2220

EMAIL: sales@swhc.com

WEB: www.swhc.com